

FALCONTM

WORKBOOK/PRICE LIST August 2015

TRAINING, MEETING & CONFERENCE TABLES
PLUS POWER SOLUTIONS



FALCON™

WORKBOOK/PRICE LIST August 2015



Contents

3	The Falcon Advantage	40	Spectra Tables
4	How to Order	54	Storm Tables
5	Base and Table Finishes	79	Syntech Tables
6	Table Top Options	87	Symetris
7	Folio Tables	92	Conference Tables
17	Mats Tables	111	Power Solutions



Solid Cast Iron Base Construction



Drilled and Tapped Glides
J-Series Uses Fully Welded Construction



Mortise and Tenon Wood Edges

The Falcon Advantage

CAST IRON BASES: DURABLE AND ENVIRONMENTALLY SOUND

- Made from 98% recycled grey iron.
- Solid cast iron (not hollow), makes the base plates dent proof.
- Multiple glide options designed to meet all flooring requirements.
- Bases are drilled and tapped for glides. We do not use glide inserts which can easily break.
- J-Series steel bases offer fully welded construction; perfect for use in high abuse or extra heavy table tops such as stone.
- Proven track record of 51 years, the longest in the industry.

BASE FINISHES: STRONG, SAFE, AND BEAUTIFUL

- Environmentally responsible, blended epoxy and polyester based powdercoat.
- Unique phosphate washing system allows powdercoat to permanently adhere to base withstanding years of use.
- Heavy nickel undercoat is used before the plating process. This important step creates our high-quality finish..

TABLE TOPS: CRAFTSMANSHIP AND DESIGN

- 45lb high-density recycled engineered core provides durability.
- Use of phenolic backing sheet prevents delamination, warping, and surface deflection.
- Mortise and tenon wood edges are durable, while minimizing dirt grabbing gaps.
- High quality finish, consisting of one sealer and two conversion varnish top coats, creates a beautiful and durable matte finish.
- Turn your vision into reality™. We are able to manufacture any size or shape table with multiple non-standard material options.

HOW TO ORDER



1. **Specify Quantity**
2. **Select Base Plus Edge Profile to equal Model Number**
 Syntech starter table/no modesty with 23000 edge
 25OCS plus edge profile number = **250CS-23000**
3. **Select Table Top Shape and Size**
 - Standard shapes and sizes are included in each pricing grid
 - Find your starting table price by selecting your edge profile grade and your table shape and size.
4. **Select Metal Base Finish**
 - See available metal finishes on next page
 - All bases are standard Grade 3 Powdercoat
5. **Select Table Top Material**
 - All prices are Grade 1 Laminate. Optional laminate grades available, call for pricing.
 - Custom wood finishes also available, call for pricing.
 - Upcharge for Long Grain Maple or Oak Veneer:
 Order must specify species or maple is provided
6. **Select Edge, Color, or Finish and Species**
 - Wood Edge - Select wood finish and species.
 - Maple species is standard.
 - Oak is optional at same price and must be specified on order.
 - Other wood species are available. Please call for quote.
 - Vinyl, Urethane, PVC - Select Color Number and Name.
 - See available Edge Colors opposite and on falconproducts.com.

7. **Specify Options**
 - Specify Base Options
 - Specify Table Top Options
 - Specify Power if Applicable
8. **F.O.B. Factory**
 - Shipped unassembled
 - Welded bases shipped setup.
9. **Freight**
 - Zone 1, Included in list price. Zone 2, Add 4% to list price
10. **Small Order Charge**
 Orders with a combined Net price under \$1,000 will be subject to a Special Handling Charge of \$125 Net. One charge per order.

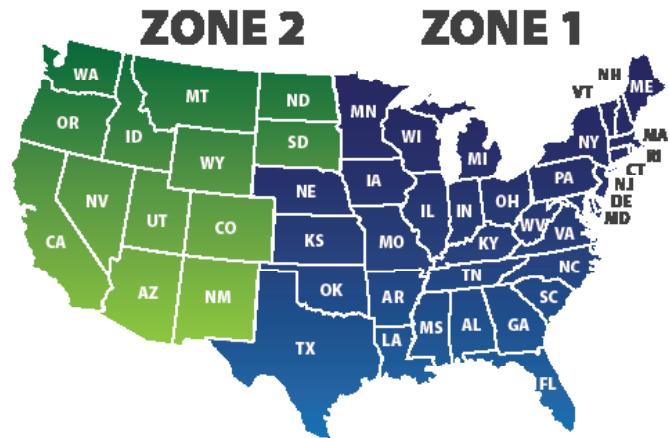

BASE AND TABLE FINISHES

METAL BASE FINISHES

Powdercoat Colors	Polished GRD 3
Absolute Black	T-13
Almond	CP010S
Aluminum	T-10
Architectural Bronze	AB-2
Black Wrinkle	R100
Bright White	T-12
Fog	CP012S
Gloss Black	CP001GS
Graphite	CP042S
Grey Iron	N351
Gunmetal	T-14
Matte Black	CP001MS
Olympic Bronze	T-9
Silvertone	E-2
Storm	CP023S
Chrome	P-3
Satin Chrome	P-4

Note: Recessed areas in bases are not polished.

Note: Designer Finishes are not recommended for outdoor use.

WOOD BASE AND TABLE FINISHES

WBF Wood Finishes	
Natural	WBF110
Golden	WBF112
Medium Oak	WBF122
Chestnut	WBF124
Medium Brown Mahogany	WBF126
Dark Walnut	WBF128
Light Cherry	WBF131
Amber Cherry	WBF134
Royal Mahogany	WBF136
Black	WBF154

Note: Wood finishes will vary due to inconsistencies in lumber and moisture; therefore we assume no responsibility for matches to exact tones. When matching to laminate patterns containing large variations in color, stain will be matched with harmonizing tone

LAMINATE TABLE FINISHES

Listed below are our most popular laminates, which are available at standard pricing and lead times.

Formica

Solid Color Portfolio (Matte Finish)
 Patterns
 Formations Collection
 Woodgrains

If you would like to see an expanded offering, please visit Formica's web site at formica.com. You may also call Formica at **1-800-FORMICA** for samples.

Should you require additional options, see selections at nevamar.com and wilsonartcontract.com. When you have made your selections, contact sales or customer service for pricing and lead time assistance. If the pricing or lead times are not to your satisfaction, we will be happy to help you reselect.

If your project requires something more unique, we can provide laminate from any manufacturer, including custom laminates. Please contact sales or customer service for assistance with pricing, lead times, and minimum order requirements.

CUSTOM FINISHES

Custom paint, metal, wood, or laminate finishes are always welcome. Falcon has the unique ability to custom tailor our products to fit your needs. Our manufacturing process is perfectly suited for custom finishes. Upcharges and additional lead time may apply. Please call Customer Service, **423-623-0031** for details.

EDGE COLORS

Almond	10
Bark	41
Black	1
Brown	2
Dark Grey	23
Dusk	P3
Graphite	42
Light Grey	12
Navy	14
Silver	50
White	949

Available on 13333 only

Cherry	WG2
Mahogany	WG3
Natural Maple	WG1

Note: Not all edge series are available in every color. See Finishes, Edge Colors or Products, Table Tops on falconproducts.com for details.

EXTENDED WARRANTY

31CT/VT and 51CT/VT - 1 Year

All Other Tables - 5 Years

These terms are in addition to the Standard Warranty are available on

www.falconproducts.com

TABLE TOP OPTIONS

T Mold



Feature	Benefit
T Mold Edge	Protects the top from incidental damage while being reconfigured or from chairs hitting against top
T Mold Edge	Stretched, pressure fit, and pinned for durability

Urethane



Feature	Benefit
Seamless Construction	Prevents moisture or bacteria from penetrating the edge
Soft Material	Forgiving when bumped against by other furniture items
Fused Material	Permanently molded into core

Wood



Feature	Benefit
Mortise and Tenon Construction	Insures years of beauty and durability and allows minimum waste
Solid Wood	Insures years of beauty and durability
Conversion Varnish Finish	Low emitting finish that is designed to hold up to the extreme demands of a dining facility
Edge on First Option	Value-priced, highly durable wood edge that is easy to clean

* Other species available upon request, order must specify

Veneer Art

Add \$25 sq ft for Standard Veneer Art

973 Euro Ash	981 Modern Makore
926 Canadian Maple	978 American Walnut
974 Brown Annigre	971 White Ash
913 Honey Annigre	976 Tropical Zebrawood
953 Renaissance Cherry	979 Bubinga
925 American Cherry	982 Architectural Sapele
921 Spanish Mahogany	980 Teak
920 Executive Mahogany	977 Bog Oak

Add \$46 sq ft for Bamboo

- 972 Natural Bamboo
- 975 Amber Bamboo
- Veneer Art provides the beauty of real wood veneer with the durability of laminate.

Table Top Features and Options

- Surface materials are standard with Grade 1 plastic laminate, but optional laminate grades, veneer, or Veneer Art are also available.
- Standard wood edge is Maple. Oak is optional at the same price. Other species are available upon request, order must specify.
- Veneer inlays are standard as long grain maple.
- Long grain oak available, order must specify
- Solid surface and Granite conference tables are available by special quote.

FALCON™

FOLIO™ TABLES

WORKBOOK/PRICE LIST August 2015

DELIVERED TO ZONE 1, ADD + 4% DELIVERED TO ZONE 2



FOLDING

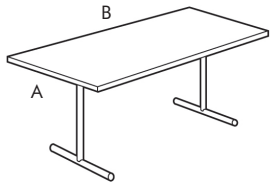

24FT RECTANGLE



Table Size A x B	Folding Leg Size	Apprx WT	1300	1333	2300	2400
18 x 60	15	89	907	917	1,094	1,235
18 x 72	15	98	917	927	1,120	1,285
18 x 84	15	107	1,033	1,047	1,210	1,502
18 x 96	15	116	1,039	1,055	1,223	1,528
24 x 60	20	106	931	942	1,097	1,358
24 x 72	20	118	1,039	1,055	1,223	1,528
24 x 84	20	130	1,165	1,185	1,368	1,854
24 x 96	20	142	1,171	1,196	1,527	1,915
30 x 60	24	122	1,011	1,025	1,138	1,378
30 x 72	24	137	1,058	1,079	1,298	1,549
30 x 84	24	152	1,203	1,230	1,484	1,870
30 x 96	24	167	1,225	1,249	1,561	1,925
36 x 60	24	139	1,042	1,059	1,271	1,624
36 x 72	24	157	1,161	1,183	1,374	1,706
36 x 84	24	175	1,377	1,407	1,733	2,162
36 x 96	24	193	1,382	1,413	1,759	2,217
42 x 72	32	188	1,545	1,573	1,905	2,354
42 x 84	32	209	1,664	1,699	2,096	2,632
42 x 96	32	230	1,681	1,721	2,130	2,684
42 x 108	32/3	276	2,446	2,492	2,974	3,622
42 x 120	32/3	296	2,471	2,518	3,018	3,686
48 x 72	38	207	1,560	1,593	1,934	2,396
48 x 84	38	231	1,664	1,699	2,096	2,632
48 x 96	38	255	1,681	1,720	2,130	2,684
48 x 108	38/3	317	2,471	2,518	3,018	3,686
48 x 120	38/3	341	2,498	2,547	3,063	3,752
48 x 144	38/3	389	2,681	2,742	3,357	4,184

• Tables above include 2 legs "/3" indicates 3 legs

24FT ROUND

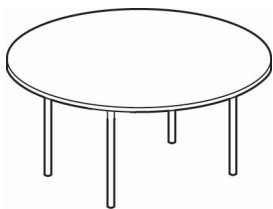

Table Size Diameter	Folding Leg Size	Apprx WT	1300	1333	2300	2400
54	1.75/4	180	1,905	1,932	2,466	2,742
60	1.75/4	190	1,933	1,963	2,496	2,772

• Tables above include 4 pin legs

NOTES

- Standard Grade 1 Laminate and any Grade 3 Powdercoat.
- Wood edges standard in Maple. Other species available, call for pricing.
- All prices are list delivered to Zone 1. Add 4% for Zone 2.
- Standard table height: 29"
- Shipped assembled.

FOLDING

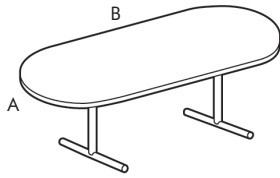

24FT RACETRACK



Table Size A x B	Folding Leg Size	Apprx WT	1300	1333	2300	2400
36 x 72	24	145	1,240	1,269	1,635	2,002
36 x 96	24	181	1,505	1,545	2,021	2,517
42 x 84	32	199	1,806	1,847	2,395	2,962
42 x 96	32	220	1,831	1,924	2,428	3,012
48 x 96	38	245	1,831	1,924	2,460	3,046
42 x 120	32/3	286	2,652	2,706	3,311	4,017
48 x 120	38/3	331	2,681	2,741	3,391	4,119

• Tables above include 2 legs *3" indicates 3 legs

LIGHTWEIGHT, FOLDING, 24FL SERIES

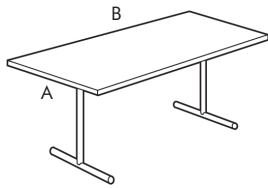

Table Size A x B	Folding Leg Size	Apprx WT	1308	1338	2308
18 x 60	15	65	1,033	1,042	1,223
18 x 72	15	72	1,042	1,055	1,246
24 x 60	20	76	1,047	1,059	1,219
24 x 72	20	80	1,165	1,181	1,351
30 x 60	24	82	1,058	1,080	1,258
30 x 72	24	90	1,184	1,201	1,422

• Tables above include 2 legs

24FA FOLDING MODESTY PANEL

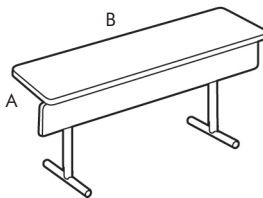
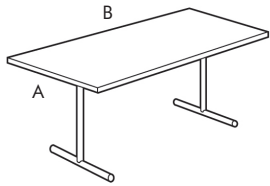

Table Size A x B	Folding Leg Size	Apprx WT	1300	2300	2400
18 x 60	15	109	1,185	1,452	1,591
18 x 72	15	124	1,224	1,507	1,676
18 x 96	15	148	1,402	1,673	1,976
24 x 60	20	126	1,256	1,436	1,699
24 x 72	20	144	1,404	1,615	1,918
24 x 96	20	174	1,611	1,975	2,361
30 x 60	24	142	1,274	1,539	1,717
30 x 72	24	163	1,447	1,685	1,937
30 x 96	24	199	1,668	2,009	2,374

• Tables above include 2 legs
• Modesty folds – not removable

STATIONARY



24TT RECTANGLE



Table Size A x B	Leg Size	Apprx WT	1300	1333	2300	2400	Veneer Upcharge
18 x 60	16	79	715	726	935	1,053	290
18 x 72	16	88	728	735	966	1,082	347
18 x 96	16	106	868	890	1,084	1,219	463
24 x 60	22	110	803	817	1,014	1,134	385
24 x 72	22	115	872	893	1,088	1,213	463
24 x 96	22	132	1,029	1,043	1,448	1,609	617
30 x 60	22	122	839	858	1,064	1,194	482
30 x 72	22	127	895	908	1,175	1,314	579
30 x 84	22	132	1,044	1,073	1,425	1,587	675
30 x 96	22	157	1,091	1,128	1,495	1,659	772

• Tables above include (2) 2400 Series end bases



24TT ROUND



Table Size Diameter	Leg Size	Apprx WT	1300	1333	2300	2400	Veneer Upcharge
30	22 x 22	57	522	530	800	904	242
36	28 x 28	75	539	669	1,124	1,270	347
42	28 x 28	90	801	820	1,208	1,377	473
48	36 x 36	125	1,031	1,051	1,470	1,699	617
60	36 x 36*	177	1,787	1,819	2,466	2,803	965

• Tables above include (1) 2400 Series pedestal base
* 5 column base for 60

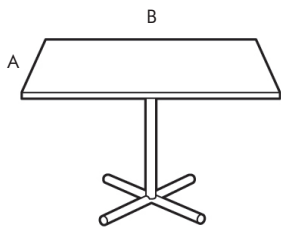

24TT SQUARE



Table Size A x B	Leg Size	Apprx WT	1300	1333	2300	2400	Veneer Upcharge
30 x 30	22 x 22	56	510	520	762	838	242
36 x 36	28 x 28	75	655	665	894	993	347
42 x 42	36 x 36	109	989	1,009	1,146	1,281	473
48 x 48	36 x 36*	136	1,511	1,532	1,702	1,903	617

• Tables above include (1) 2400 Series pedestal base
* 5 column base for 48 x 48

NOTES

- Standard Grade 1 Laminate and any Grade 3 Powdercoat.
- Wood edges standard in Maple. Other species available, call for pricing.
- All prices are list delivered to Zone 1. Add 4% for Zone 2.
- Standard table height: 29"
- Ships unassembled

STATIONARY

**24TM
FIXED MODESTY PANEL**

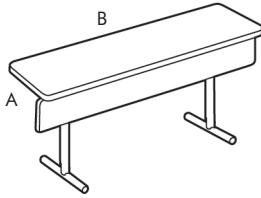
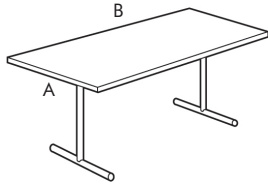

Table Size A x B	Leg Size	Apprx WT	1300	1333	2300	2400	Veneer Upcharge
18 x 60	16	109	1,029	1,041	1,346	1,548	482
18 x 72	16	124	1,075	1,082	1,413	1,627	579
18 x 96	16	148	1,284	1,302	1,606	1,846	733
24 x 60	22	126	1,116	1,134	1,424	1,637	579
24 x 72	22	144	1,218	1,238	1,539	1,769	694
24 x 96	22	174	1,443	1,470	1,969	2,264	888
30 x 60	22	142	1,155	1,172	1,473	1,694	675
30 x 72	22	163	1,242	1,446	1,629	1,874	811
30 x 96	22	199	1,506	1,534	2,014	2,315	1,041

• Tables above include (2) 2400 Series end bases

STATIONARY SHAPES



24TS RECTANGLE



Wood Edges Only

Table Size A x B	Leg Size	Apprx WT	1333	2300	2400	Veneer Upcharge
24 x 48	22	100	783	969	1,074	309
24 x 60	22	110	817	1,014	1,134	385
24 x 72	22	115	893	1,088	1,213	463
30 x 60	22	122	858	1,064	1,194	482
30 x 72	22	127	908	1,175	1,314	579
36 x 72	32*	150	1,068	1,392	1,549	694

- Tables above include (2) 2400 Series end bases
- 36 x 72 requires 2 columns

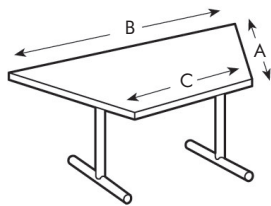

24TS TRAPEZOID



Wood Edges Only

Table Size A x B x C	Leg Size	Apprx WT	1333	2300	2400	Veneer Upcharge
24 x 48 x 24	16	100	903	1,120	1,243	309
30 x 60 x 30	22	122	1,020	1,283	1,439	482
36 x 72 x 36	22	150	1,167	1,525	1,697	694

- Tables above include (2) 2400 Series end bases

NOTES

- Standard Grade 1 Laminate and any Grade 3 Powdercoat.
- Wood edges standard in Maple. Other species available, call for pricing.
- All prices are list delivered to Zone 1. Add 4% for Zone 2.
- Standard table height: 29"
- Ships unassembled

STATIONARY SHAPES

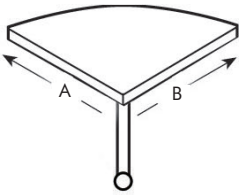

24TS
QUARTER ROUND



Table Size A x B	Leg Size	Apprx WT	1333	2300	2400	Veneer Upcharge
24 x 24	22 x 22	44	731	901	979	155
30 x 30	22 x 22	60	776	1,080	1,190	242
36 x 36	28 x 28	120	845	1,259	1,400	347

- Tables above include (1) 2400 Series end base
- Table must be ganged

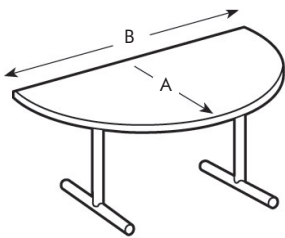

24TS
HALF ROUND



Table Size A x B	Leg Size	Apprx WT	1333	2300	2400	Veneer Upcharge
24 x 48	16	100	902	1,160	1,289	309
30 x 60	22	122	1,024	1,356	1,520	482
36 x 72	22	150	1,167	1,593	1,773	694

- Tables above include (2) 2400 Series end bases

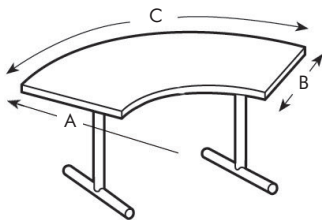

24TS
CRESCENT



Table Size A x B x C	Leg Size	Apprx WT	1333	2300	2400	Veneer Upcharge
48 x 24 x 75	16	120	1,214	1,600	1,841	1,157
60 x 24 x 94	16	140	1,497	2,228	2,561	1,736
48 x 30 x 75	22	130	1,246	1,636	1,883	1,157
60 x 30 x 94	22	154	1,551	2,301	2,647	1,697
48 x 36 x 75	32*	140	1,279	1,670	1,921	1,157
60 x 36 x 94	32*	165	1,606	2,358	2,712	1,697

- Tables above include (2) 2400 Series end bases
- * 48 x 36 x 75 and 60 x 36 x 94 require 2 (2400) end bases, each with 2 columns

SPECIFICATIONS

HOW TO ORDER

When ordering please specify:

1. Model Number & Edge Selection Number
2. Quantity
3. Shape
4. Size
5. Base Finish
6. Top Selection (laminare pattern number and description, veneer finish number and description)
7. Edge Finish Selection (specify wood finish and species if ordering wood edges)
8. Options
9. Small Order Charge
Orders with a combined Net price under \$1,000 will be subject to a Special Handling Charge of \$125 Net. One charge per order.

• For additional sizes and shapes, visit falconproducts.com

EDGE AND MODESTY PROFILES



1300 / 1308 Bumper T-Mold
1-1/4" laminate top. The edges are banded with solid vinyl "T" molding, with 3" radius at corners.
Modesty edge 1300

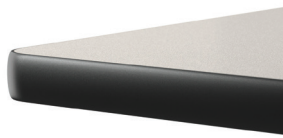

1333 / 1338 Eased T-Mold
1-1/4" laminate top. The edges are banded with solid vinyl "T" molding, with 1" radius at corners.
Modesty edge 1300



2300 / 2308 Wood Band
1-1/4" laminate top. The edges are banded with 1/4" hardwood. No radius at corners.
Modesty edge Flat Wood Band

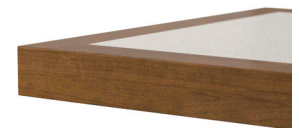

2400 Wood Edge
1-1/4" laminate top. The edges are banded with hardwood. No radius at corners.
Modesty edge Flat Wood Band

STANDARD TABLE HEIGHT: 29"

TOP CONSTRUCTION

Substrate

High density 45 lb. core with backing sheet

Laminate

.050 thick high pressure plastic manufactured to N.E.M.A. standards, .045 thick phenolic resin sheet on underside.

Light Weight Top

Most light weight tops produced using light weight composite wood construction, specially designed to provide light weight rigidity. The core is 7/8" thick. Edges are built up to 1-1/4" using 1/4" fiberboard on perimeter of frame. Tops are balanced construction with plastic laminate or veneer surfaces and phenolic backer.

OPTIONS

GROMMETS



GRM2 - Grommet

- \$82
- Size: 1-3/4" Diameter
- Factory installed
- Standard location: 3" from back edge and 6" from right short edge
- Standard center location: 3" from back edge and center of table length.
- Black is standard

GANGING

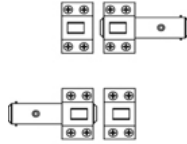

GA4 Ganging Device \$148

- Factory installed
- Specify ganging configuration, e.g. end to end, side to end, side to side, etc



WIRE MANAGEMENT

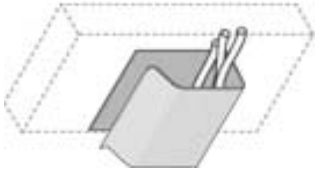

WM2 - Under Table Wireway \$86

- Up to 72" long table
- Black only

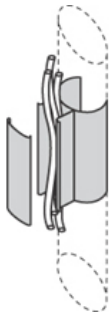

WM6B - Leg Wireway \$71

- Tables with 1-3/4 to 2" Diameter Columns
- Black only

MOBILITY



CS4 - Casters \$118 (set of 4)

- 2 locking and 2 non-locking per table
- Must be noted at time of order.
- Not available on pin legs
- Color: Black plastic.

HEIGHT ADJUSTABLE

NLU-36 - Lift Mechanism-Pedestal Base \$405

- Height of top will adjust 12"
- Maximum weight lift engaged 100 lbs
- Lift mechanisms are not gangable
- For 2400 series base only
- For 42" Square and Round Stationary Tables only

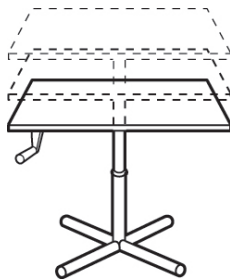

STORAGE TRUCKS

- Casters: 2 locking and 2 swivel
- Finish is CP001MSMatte Black with Grey carpeted bed.

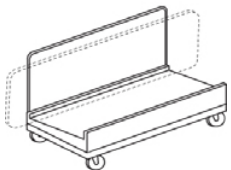

TT23042 Set Up Aid Tilt Truck- Rectangles

- \$1,467
- 80 lb
- 30" x 42"
- Maximum Capacity: 7 Tables

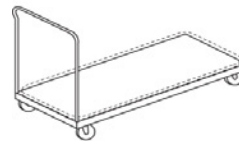

Flat Table Truck- Rectangles

- \$1,454
- 90 lb
- 30" x 96"
- Maximum Capacity: 10 Tables

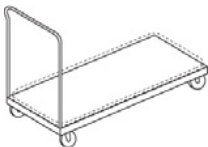

TT43072 Flat Table Truck- Rectangles

- \$1,441
- 80 lb
- 30" x 72"
- Maximum Capacity: 10 Tables

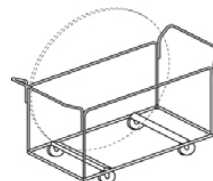

TT23060 Table Truck- Rounds

- \$1,576
- 95 lb
- 28.5" x 60"
- Maximum Capacity: 7 Tables
- Handles remove for easy folding

FINISHES

Additional standard and optional finishes available at falconproducts.com

Wood Colors



Metal Powdercoat Colors

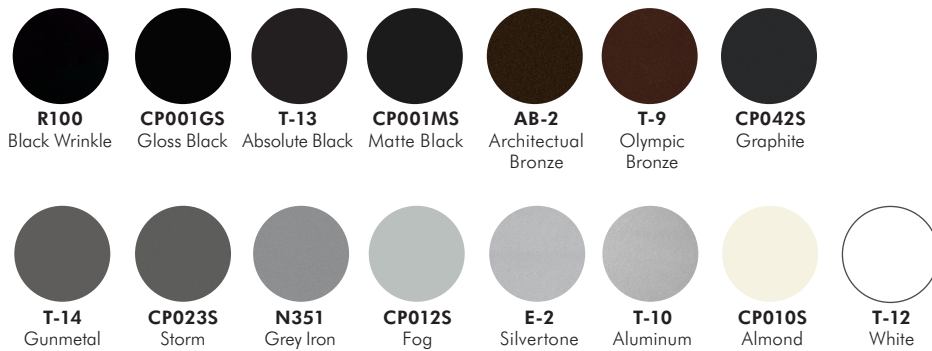

Vinyl Edges Colors Not all colors available on every edge profile. Visit falconproducts.com for more information.

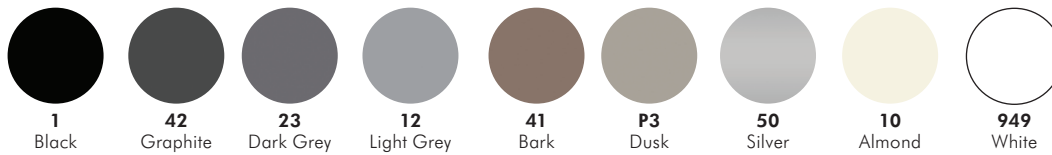

FALCONTM

MATSTM TABLES

WORKBOOK/PRICE LIST August 2015

DELIVERED TO ZONE 1, ADD + 4% DELIVERED TO ZONE 2



FALCON™

MATS: MULTIPLE APPLICATION TABLE SYSTEMS

Contents

Portable

- 19 Lightweight Folding
- 21 Shapes and Configurations

Freestanding

- 22 Freestanding Stationary
- 24 Pedestal and Pin Leg Tables
- 25 Lift and Flip Options
- 26 Portable and Freestanding Table Options

Lecture

- 27 Lecture Hall

Shared Leg

- 28 Stationary Tables
- 30 Screen Groups
- 33 Modesty Panels and ADA Compliance

Custom Capabilities and Planner

- 34 Turn Your Vision Into Reality™
- 35 MATS Project Planner and Checklist

Ordering Information and Power Solution

- 36 Ordering Guidelines
- 37 MATS Power Solution

Edges and Colors

- 38 Edge Profiles, Colors and Laminates
- 38 Finishes

PORTABLE Lightweight Folding

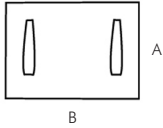

RECTANGLE



Table Size A x B	Apprx WT	Cantilever Leg	T-mold Vinyl 1357	Urethane 4157	Urethane 4167
24 x 42	58	20FC+	1,162	1,421	
24 x 48	62	20FC+	1,172	1,439	
24 x 60	72	20FC+	1,196	1,469	
24 x 72	78	20FC+	1,215	1,508	
30 x 42	62	20FC+	1,172	1,439	
30 x 48	68	20FC+	1,196	1,469	
30 x 60	78	20FC+	1,215	1,508	
30 x 72	86	20FC+	1,276	1,598	
36 x 60	86	N/A+	1,459	N/A	
36 x 72	94	N/A+	1,749	N/A	

- **4157 edge on one B side. Other sides are flat urethane (4167).**
- + Available with symmetrical leg (20FS), same price.
- WM1 wire modesty gallery available on all cantilever tables, add \$368 each.
- WM1 wire modesty gallery available only on 30" and 36" symmetrical tables (20FS), add \$346 each.

LEG OPTIONS



Cantilever Leg
20FC



Symmetrical Leg
20FS

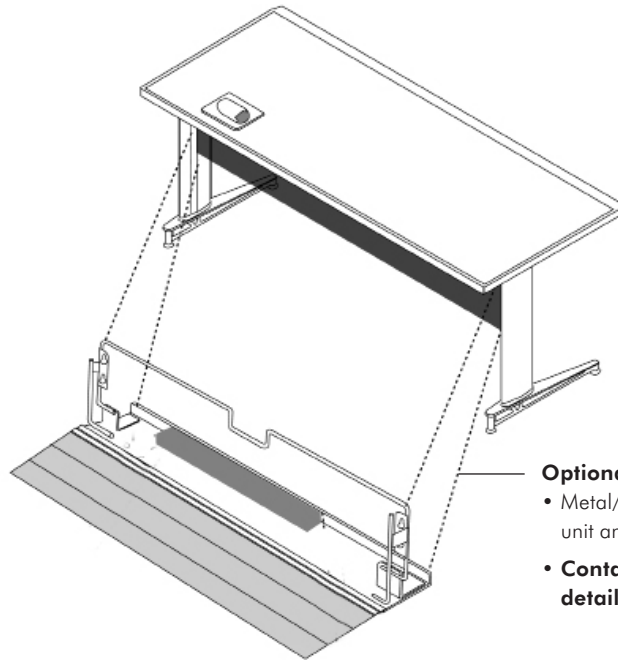

- Optional Removable Modesty Wire Gallery**
- Metal/mesh housing that holds the power distribution unit and electrical/communication wires. (WM1).
 - **Contact Sales or Customer Service for detailed electrical options.**

PORTABLE Lightweight Folding

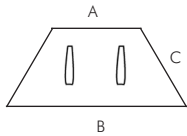

TRAPEZOID

Table Size A x B x C	Apprx WT	Symmetrical Leg	T-mold Vinyl 1357	Urethane 4167
30 x 60 x 30	60	20FS	1,439	1,652



• Symmetrical leg only.

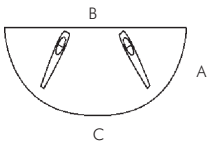

HALF ROUND

Table Size A x B x C	Apprx WT	Cantilever Leg	T-mold Vinyl 1357	Urethane 4157
25 x 50 x 78	52	20FC	1,413	1,616
31 x 62 x 97	67	20FC	1,511	1,760
24 x 48 x 75	50	20FC**	1,470	1,681

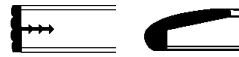

• 4157 edge on one C side. Other sides are flat urethane (4167).

• Cantilever leg only.

• **Allows for racetrack configuration w/o 2" center slot when ganged with rectangles.

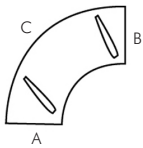

QUARTER CIRCLE CRESCENT

Table Size A x B x C	Apprx WT	Cantilever Leg	T-mold Vinyl 1357	Urethane 4157
36R x 24 x 56	52	20FC	1,413	1,616
48R x 24 x 75	65	20FC	1,511	1,760
48R x 30 x 75	70	20FC	1,554	1,815

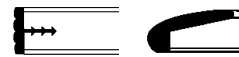

• 4157 edge on one C side. Other sides are flat urethane (4167).

• Cantilever leg only.

LEG OPTIONS

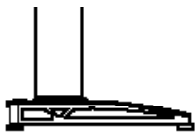

Cantilever Leg
20FC



Symmetrical Leg
20FS

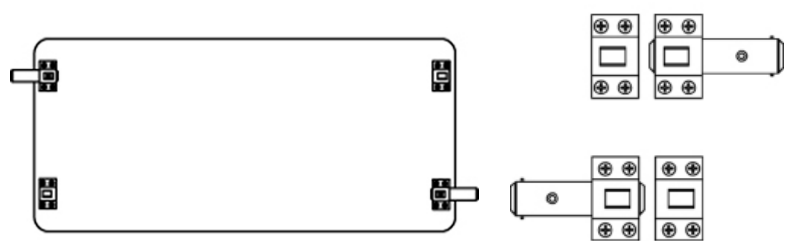

Ganging Device

All trapezoid, half round and quarter circle crescent tables include one set of gangers, which ship installed. Order additional ganging devices for the tables to be connected.

Drawing noting ganger placement required.

NOTE • Wood edges standard in Maple. Other species available, call for quote.

• WM1 wire modesty gallery not available.

PORTABLE Shapes and Configurations

SHAPES



Rectangle



Trapezoid



Half Round



Crescent



Quarter Round
Connector



30° Connector. Also available in:
15°, 45°, 60°, and straight

CONFIGURATIONS

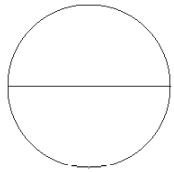

Round

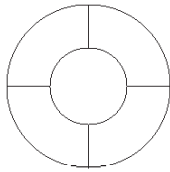

Circle

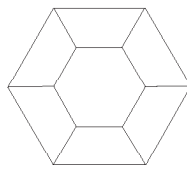

Hexagon-6

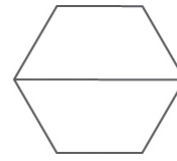

Hexagon-2

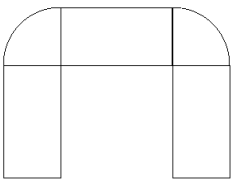

Horseshoe



Racetrack



Open Racetrack

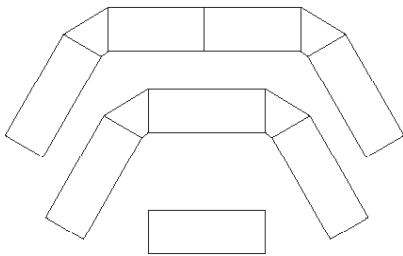

Classroom

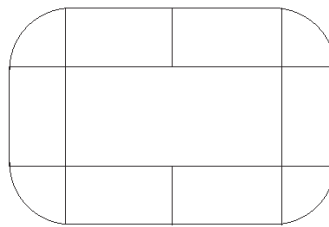

Enclosed U

FREESTANDING Stationary

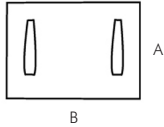
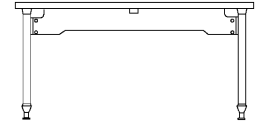

RECTANGLE



Table Size A x B	Apprx WT	Cantilever Leg	T-mold Vinyl 1350	Urethane 4150	Urethane 4160	Wood 2300
18 x 42	25	20TC	950	N/A		1,121
18 x 48	27	20TC	957	N/A		1,135
18 x 60	34	20TC	977	N/A		1,159
18 x 72	41	20TC	993	N/A		1,184
24 x 42	68	20TC	990	1,212		1,167
24 x 48	72	20TC	996	1,232		1,184
24 x 60	88	20TC	1,017	1,276		1,208
24 x 72	99	20TC	1,035	1,283		1,232
30 x 42	77	20TC+	996	1,232		1,184
30 x 48	82	20TC+	1,017	1,276		1,208
30 x 60	101	20TC+	1,035	1,283		1,232
30 x 72	115	20TC+	1,085	1,368		1,308

- 4150 edge on B side only. Other sides are flat urethane (4160).
- * Also available with symmetrical leg (20TS), same price.
- WM1 wire modesty gallery available, \$377 per table.

LEG OPTIONS



Cantilever Leg
20TC



Symmetrical Leg
20TS

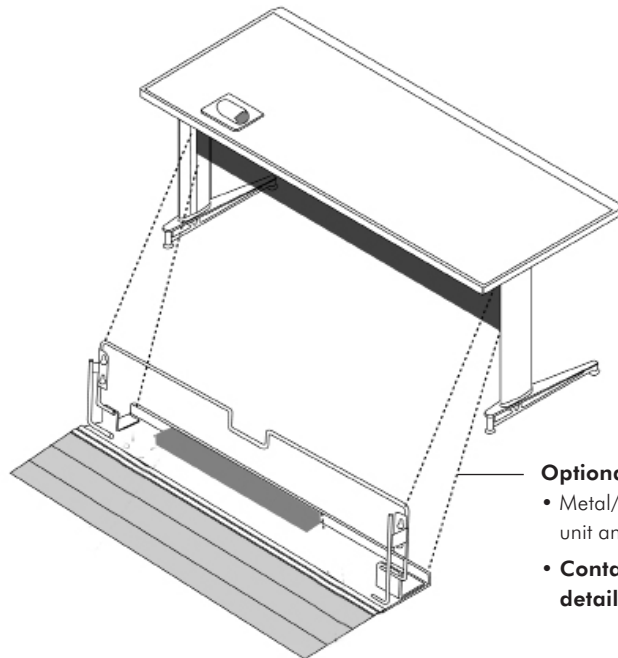

Optional Removable Modesty Wire Gallery

- Metal/mesh housing that holds the power distribution unit and electrical/communication wires. (WM1).
- **Contact Sales or Customer Service for detailed electrical options.**

NOTE • Wood edges standard in Maple. Other species available, call for quote.

FREESTANDING Stationary

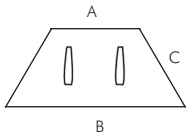

TRAPEZOID



Table Size A x B x C	Apprx WT	Symmetrical Leg	T-mold Vinyl 1350	Urethane 4160	Wood 2300
30 x 60 x 30	79	20TS	1,219	1,524	1,436

• Symmetrical leg only.

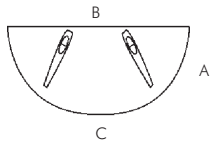

HALF ROUND

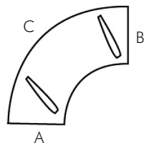

Table Size A x B x C	Apprx WT	Cantilever Leg	T-mold Vinyl 1350	Urethane 4150	Wood 2300
25 x 50 x 78	62	20TC	1,198	1,457	1,405
31 x 62 x 97	83	20TC	1,285	1,584	1,524
24 x 48 x 75	59	20TC**	1,331	1,513	1,462

• 4150 edge on C side only. Other sides are flat urethane (4160).

• Cantilever leg only.

• **Allows for racetrack configuration w/o 2" center slot when ganged with rectangles



QUARTER CIRCLE CRESCENT



Table Size A x B x C	Apprx WT	Cantilever Leg	T-mold Vinyl 1350	Urethane 4150	Wood 2300
36R x 24 x 56	61	20TC	1,198	1,457	1,405
48R x 24 x 75	77	20TC	1,285	1,584	1,524
48R x 30 x 75	87	20TC	1,320	1,633	1,530

• 4150 edge on C side only. Other sides are flat urethane (4160).

• Cantilever leg only.

LEG OPTIONS



Cantilever Leg
20TC



Symmetrical Leg
20TS

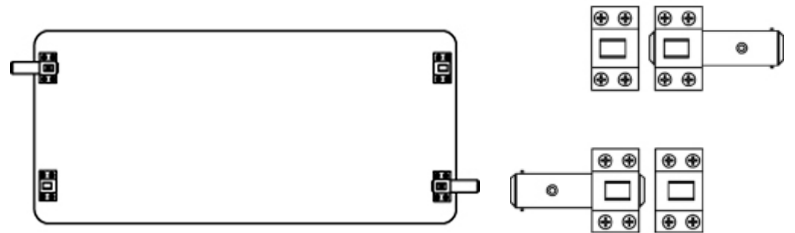

Ganging Device

All trapezoid, half round and quarter circle crescent tables include one set of gangers, which ship installed. Order additional ganging devices for the tables to be connected.

Drawing noting ganger placement required.

NOTE • Wood edges standard in Maple. Other species available, call for quote.
• WM1 wire modesty gallery not available

FREESTANDING Pedestal and Pin Leg

PEDESTAL BASE



SQUARE

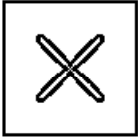

Table Size	Apprx WT	Model	T-mold Vinyl 1350	Urethane 4160	Wood 2300
36 x 36	64	20TX	614	879	788
42 x 42	83	20TX	768	976	843

ROUND

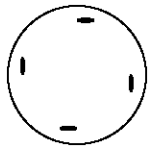

Table Size	Apprx WT	Model	T-mold Vinyl 1350	Urethane 4160	Wood 2300
42Rd	70	20TX	776	1,143	1,038
48Rd	79	20TX	930	1,194	1,248

• △ 4150 edge also available, same price.

NOTE • Accent collar for Pedastak bases onyl available in Black

PIN LEG BASE



ROUND

Table Size	Apprx WT	Model	T-mold Vinyl 1350	Urethane 4160	Wood 2300
48Rd	104	20TP	1,185	1,497	1,509
60Rd	141	20TP	1,461	1,773	1,957

BASES

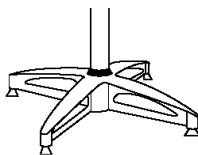

Pedestal Base







Pin Leg Base

• Wood edges standard in Maple. Other species available, call for quote.

FREESTANDING Lift Mechanisms & Flip Tops Options

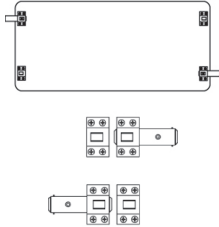
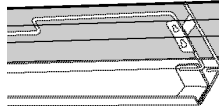
MODEL	DESCRIPTION	PRICE
20TC2IL	<p>Manual/Incremental - Lift Mechanism</p> <ul style="list-style-type: none"> • Available on MATS fixed base rectangles. • Not available on pin leg tables or pedestal bases, folding legs, or tables with casters, or modesty panels. • Wire Manager does not move up with table top. • Incremental Manual Pin Adjustment - adjustable from 29" to 40" in 1" increments. • Maximum weight with lift mechanism engaged: 300lbs. • Left mechanism are not gangable. • Weight: 1 lb. 	661
FTD3	<p>Flip Top Mechanism</p> <ul style="list-style-type: none"> • Fixed Base Tables only - Pedestal Base. • For use with Falcon table tops only. • Maximum table tops for use: 42" square, 48" round, 30" x 48" rectangle. • 10 gauge steel. • Weight: 6 lbs. 	202

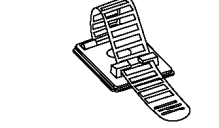
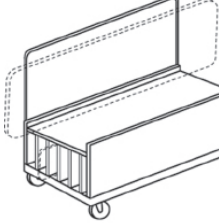
PORTABLE AND FREESTANDING OPTIONS

MODEL	DESCRIPTION	PRICE
	<p>GA2</p> <p>Ganging Device</p> <ul style="list-style-type: none"> • One set per top required, ships installed. • Include ganger placement drawing with your order 	148
	<p>WM1</p> <p>Wire Modesty Gallery</p> <ul style="list-style-type: none"> • Available on fixed and folding base tables. • Remove gallery before folding table • Color: Black • 7.089" High • Weight: 8lb (4kg) 	395
	<p>UG1</p> <p>Upper Modesty Panel with 3/4" T-Mold Edge</p> <ul style="list-style-type: none"> • Removable clamp on attachment • Specify length of table • Weight: 12 lb (6kg) 	314
	<p>CC1</p> <p>Cable Clip - Adjustable</p> <ul style="list-style-type: none"> • Includes: 2 clips and 2 mounting screws 	25
	<p>TT203042</p> <p>Set Up Aid Tilt Truck - Rectangles</p> <ul style="list-style-type: none"> • Maximum Capacity: 5 Tables & 6 wire modesty galleries • Finish: CP001MS Matte Black • Carpet: Grey • Casters: 2 locking, 2 swivel • Size: 30" X 42" (76.2 cm X 106.7 cm) • Truck slots are designed to hold modesty panels • Weight: 140lb (64kg) 	2,761
	<p>CS5</p> <p>Casters (2 locking / 2 non-locking per table)</p> <ul style="list-style-type: none"> • Not for use with pin leg units or units with upper cabinets • Must be specified at the time of order • Leg is shortened to accommodate caster height • Set of 4 	139

LECTURE Features & Benefits



Attached Chair and Table Features



Access to data and power



Sturdy base for support

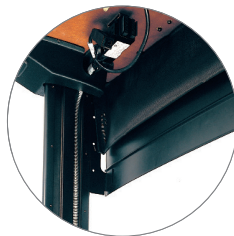

U.L. approved electrical system



Verona Seating by Falcon



Reva Seating by Thonet

Both seating units feature 360° Rotation -
Self Returning Swivel Seat and Swing Design

Attached Table Features



Perforated Steel Modesty



Contoured Steel Modesty

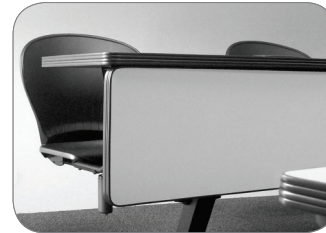

Laminated Modesty Panel

NOTE • Contact your sales representative for more information.

SHARED LEG 29" Height Basic Stationary Tables

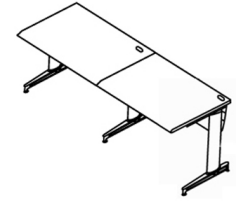

41S - FREESTANDING/STARTER

Top Size	Apprx WT	Model	Laminate/ PVC 4720	Urethane 4150
24 x 30	69	41S29	1,038	1,167
24 x 36	76	41S29	1,081	1,216
24 x 42	82	41S29	1,143	1,232
24 x 48	88	41S29	1,190	1,297
24 x 54	100	41S29	1,271	1,466
24 x 60	106	41S29	1,315	1,525
24 x 72	122	41S29	1,452	1,689
30 x 30	77	41S29	1,060	1,192
30 x 36	84	41S29	1,109	1,251
30 x 42	92	41S29	1,175	1,322
30 x 48	99	41S29	1,224	1,384
30 x 54	112	41S29	1,311	1,499
30 x 60	119	41S29	1,357	1,557
30 x 72	138	41S29	1,504	1,726

- 4720 edge on user side only. Other sides are flat PVC.
- 4150 edge on user side only. Other sides are flat urethane (4160).

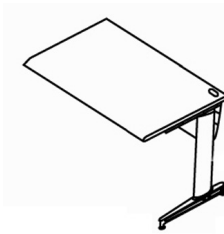

42A - ADD ON

Top Size	Apprx WT	Model	Laminate/ PVC 4720	Urethane 4150
24 x 30	56	42A29	821	951
24 x 36	63	42A29	864	1,000
24 x 42	69	42A29	926	1,081
24 x 48	75	42A29	975	1,129
24 x 54	87	42A29	1,052	1,251
24 x 60	93	42A29	1,101	1,310
24 x 72	109	42A29	1,238	1,473
30 x 30	63	42A29	847	977
30 x 36	71	42A29	894	1,038
30 x 42	78	42A29	960	1,109
30 x 48	85	42A29	1,010	1,170
30 x 54	98	42A29	1,099	1,283
30 x 60	106	42A29	1,143	1,342
30 x 72	124	42A29	1,288	1,508

- 4720 edge on user side only. Other sides are flat PVC.
- 4150 edge on user side only. Other sides are flat urethane (4160).

- Also available in 27" Keyboard height and 38" Stand up height, special quote needed
- Contact Customer Service or Sales for more information.

NOTE • Basic Table includes top, cantilever legs, technology support gallery, and one right hand grommet (up to 48"), two grommets, right and left (over 48").

SHARED LEG 29" Height Corner Stationary Table



41S - CORNER CHAMFER, FREESTANDING/STARTER

Top Size	Apprx WT	Model	Laminate/PVC 4720	Urethane 4150
48 x 48 x 24 x 24	128	41S29	2,690	2,738



- 4720 edge on user side only. Other sides are flat PVC.
- 4150 edge on user side only. Other sides are flat urethane (4160).

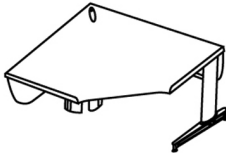

42A - CORNER CHAMFER, ADD ON

Top Size	Apprx WT	Model	Laminate/PVC 4720	Urethane 4150
48 x 48 x 24 x 24	115	42A29	2,155	2,229

- 4720 edge on user side only. Other sides are flat PVC.
- 4150 edge on user side only. Other sides are flat urethane (4160).

- Also available in 27" Keyboard height and 38" Stand Up height.
- Contact Customer Service or Sales for more information.



Shared Leg Tables - 29" Height Basic Stationary Tables



Wire Management Gallery

NOTE • Basic Corner Table includes top, pin legs, and cantilever legs, technology support galleries, and one center grommet.

SCREEN GROUPS In-Line Screen Grouping

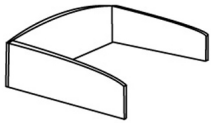

41LD - FREESTANDING/STARTER

Table Size	Screen Size	11" Height	17" Height
24 x 30	19 x 30	517	600
24 x 36	19 x 36		
24 x 42	19 x 42		
30 x 30	25 x 30		
30 x 36	25 x 36		
30 x 42	25 x 42		
24 x 48	19 x 48	550	645
24 x 54	19 x 54		
24 x 60	19 x 60		
30 x 48	25 x 48		
30 x 54	25 x 54		
30 x 60	25 x 60		
24 x 72	19 x 72	580	674
30 x 72	25 x 72		

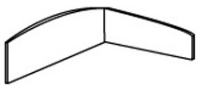

42LD - ADD ON

Table Size	Screen Size	11" Height	17" Height
24 x 30	19 x 30	372	429
24 x 36	19 x 36		
24 x 42	19 x 42		
30 x 30	25 x 30		
30 x 36	25 x 36		
30 x 42	25 x 42		
24 x 48	19 x 48	404	474
24 x 54	19 x 54		
24 x 60	19 x 60		
30 x 48	25 x 48		
30 x 54	25 x 54		
30 x 60	25 x 60		
24 x 72	19 x 72	434	504
30 x 72	25 x 72		

NOTE • Freestanding/Starter Screen Grouping includes:

- Back Screen
- Two Divider Screens
- Brackets

• Add On includes:

- Back Screen
- One divider screen
- Hardware



In-Line Screen Grouping

SCREEN GROUPS Back-to-Back Screen Grouping

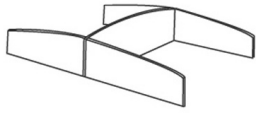

41BD - FREESTANDING/STARTER

Table Size	Screen Size	11" Height	17" Height
24 x 30	19 x 30	858	990
24 x 36	19 x 36		
24 x 42	19 x 42		
30 x 30	25 x 30		
30 x 36	25 x 36		
30 x 42	25 x 42		
24 x 48	19 x 48	893	1,035
24 x 54	19 x 54		
24 x 60	19 x 60		
30 x 48	25 x 48		
30 x 54	25 x 54		
30 x 60	25 x 60		
24 x 72	19 x 72	924	1,065
30 x 72	25 x 72		

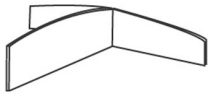

42BD - ADD ON

Table Size	Screen Size	11" Height	17" Height
24 x 30	19 x 30	569	648
24 x 36	19 x 36		
24 x 42	19 x 42		
30 x 30	25 x 30		
30 x 36	25 x 36		
30 x 42	25 x 42		
24 x 48	19 x 48	604	694
24 x 54	19 x 54		
24 x 60	19 x 60		
30 x 48	25 x 48		
30 x 54	25 x 54		
30 x 60	25 x 60		
24 x 72	19 x 72	631	724
30 x 72	25 x 72		

NOTE • Freestanding/Starter includes:

- Back Screen
- Four Divider Screens
- Brackets

• Add On includes:

- Back Screen
- Two Divider Screens
- Hardware

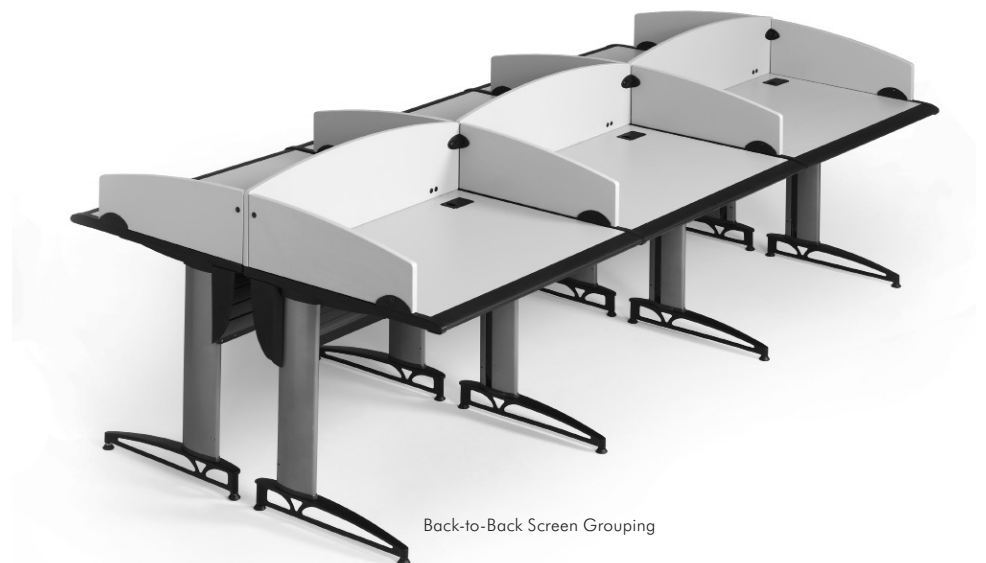

Back-to-Back Screen Grouping

SCREEN GROUPS Corner Screen Grouping

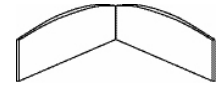

41LC - FREESTANDING/STARTER

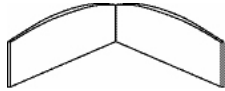

Table Size	Screen Size	11" Height	17" Height
24 x 48	48 x 48	436	507
30 x 48	48 x 48	436	507

42LC - ADD ON

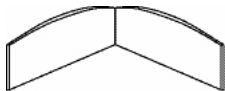

Table Size	Screen Size	11" Height	17" Height
24 x 48	48 x 48	436	507
30 x 48	48 x 48	436	507

SCREEN GROUPS Back-to-Back Corner Screen Grouping

41S - FREESTANDING/STARTER

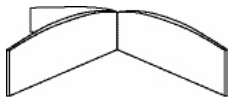

Table Size	Screen Size	11" Height	17" Height
24 x 48	48 x 48 x 48	668	774
30 x 48	48 x 48 x 48	668	774

42A - ADD ON

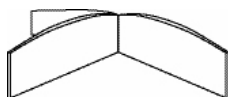

Table Size	Screen Size	11" Height	17" Height
24 x 48	48 x 48 x 48	668	774
30 x 48	48 x 48 x 48	668	774

- NOTE**
- **Freestanding/Starter and Add On Corner Screen Grouping includes:**
Two Back Screens
Brackets
 - **Freestanding/Starter and Add On Back-to-Back Corner Screen Grouping includes:**
Three Back Screens
Brackets
 - **Corner screens are for use on 41S and 42A Corner Tables.**



Corner Screen Grouping

STARTER & ADD ON MODESTY PANELS Lower Modesty Panels



FOR FREESTANDING UNITS

Table Widths	Catalog Number	Price
30, 36, 42	MODP2	241
48, 54, 60	MODP2	298
72	MODP2	312
Table width - Corner 48 (2 panels)	MODP2C	507



FOR STARTER & END OF RUN

Table Widths	Catalog Number	Price
30, 36, 42	MODPS	241
48, 54, 60	MODPS	298
72	MODPS	312
Table width - Corner 48 (2 panels)	MODPSC	507



FOR ADD ON UNITS

Table Width	Catalog Number	Price
30, 36, 42	MODPA	241
48, 54, 60	MODPA	298
72	MODPA	312
Table width - Corner 48 (2 panels)	MODPAC	507

ADA COMPLIANCE Wheelchair Adapter Kits

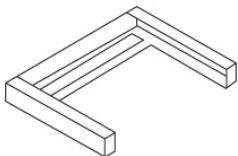

FOR 29" H TABLES

Catalog Number	WCK49 Price
WCK49	523

When ordering, note table length and width.
Only available on 30" deep tables.

Is change relevant to the copy?

NOTE • Wheel Chair Adapter Kit includes Black Laminate ADA Compliance Kit and attaching hardware.

• Lower Modesty Panel available in Matte Black laminate.



Lower Modesty Panel

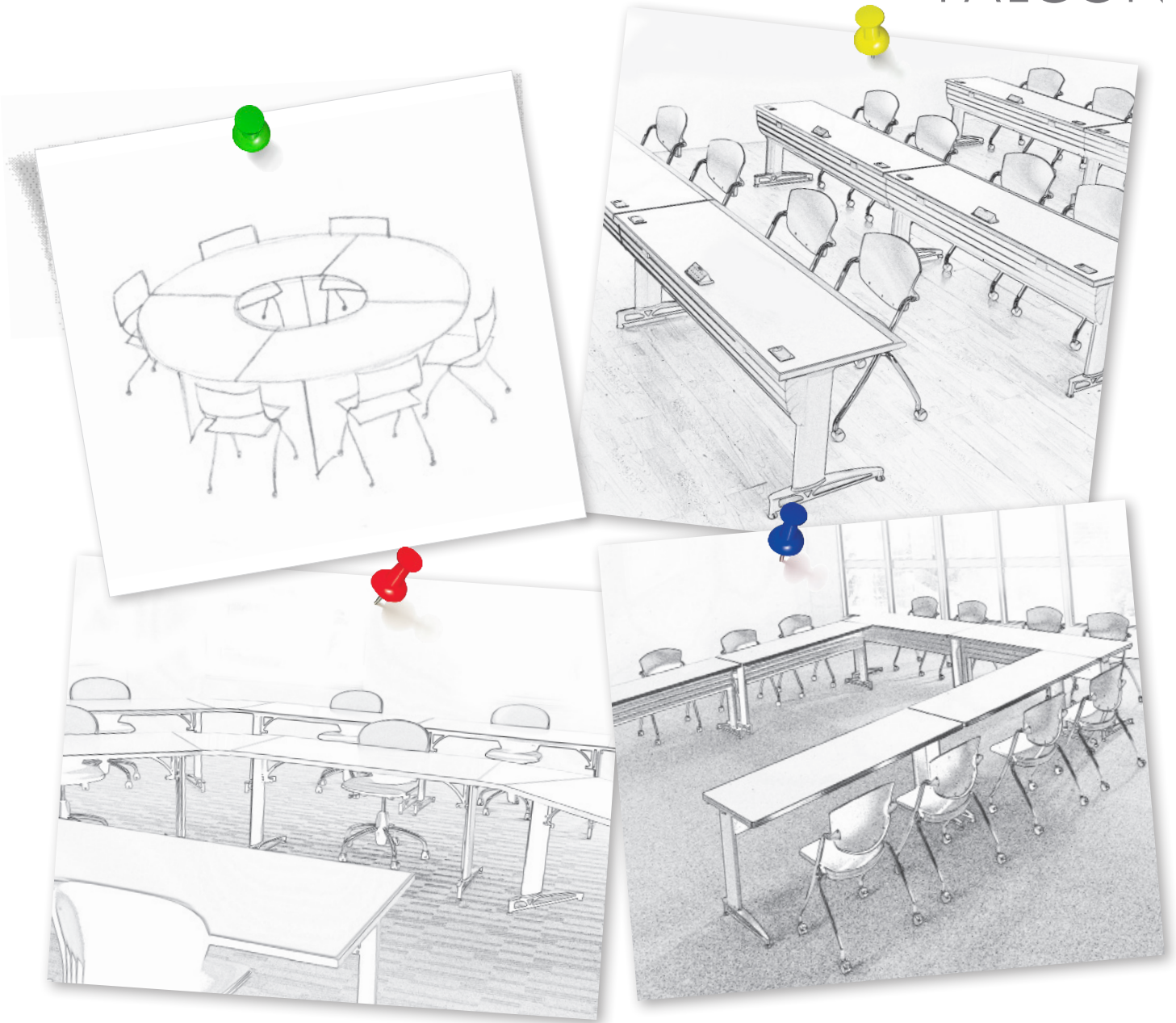

TURN YOUR VISION INTO REALITY™

If you don't see the product that you are looking for to fit a special space or design, don't panic. We offer total custom manufacturing capabilities.

We can work with almost any material, finish, and specification to fit any need. Send us a photograph, CAD drawing, or sketch and we will do everything possible to turn your vision into reality.

We offer full custom capabilities

- Training rooms, lecture halls, computer labs, testing stations, and classrooms
- Custom shapes and sizes to fit unique applications or ideas
- Speciality power solutions
- Built in or reconfigurable products
- Custom laminates and special finishes available

MATS PROJECT PLANNER AND CHECKLIST

We have found that the following information is key to helping you determine what product is best for your application needs, as well as helping to insure the smoothest possible on-time delivery and installation of your project. We have provided the following tool to assist you in your project planning.

	Name/Address	Phone	Email	Fax	Comments
Step One Document and share key contact information with all parties at the earliest possible stage and keep it updated.					
1. Dealer Contacts					
Sales Manager	<input type="checkbox"/> Y <input type="checkbox"/> N <input type="checkbox"/> TBD	<input type="checkbox"/> Y <input type="checkbox"/> N <input type="checkbox"/> TBD	<input type="checkbox"/> Y <input type="checkbox"/> N <input type="checkbox"/> TBD	<input type="checkbox"/> Y <input type="checkbox"/> N <input type="checkbox"/> TBD	_____
Sales Representative	<input type="checkbox"/> Y <input type="checkbox"/> N <input type="checkbox"/> TBD	<input type="checkbox"/> Y <input type="checkbox"/> N <input type="checkbox"/> TBD	<input type="checkbox"/> Y <input type="checkbox"/> N <input type="checkbox"/> TBD	<input type="checkbox"/> Y <input type="checkbox"/> N <input type="checkbox"/> TBD	_____
Accounts Payable	<input type="checkbox"/> Y <input type="checkbox"/> N <input type="checkbox"/> TBD	<input type="checkbox"/> Y <input type="checkbox"/> N <input type="checkbox"/> TBD	<input type="checkbox"/> Y <input type="checkbox"/> N <input type="checkbox"/> TBD	<input type="checkbox"/> Y <input type="checkbox"/> N <input type="checkbox"/> TBD	_____
Logistics/Install Manager	<input type="checkbox"/> Y <input type="checkbox"/> N <input type="checkbox"/> TBD	<input type="checkbox"/> Y <input type="checkbox"/> N <input type="checkbox"/> TBD	<input type="checkbox"/> Y <input type="checkbox"/> N <input type="checkbox"/> TBD	<input type="checkbox"/> Y <input type="checkbox"/> N <input type="checkbox"/> TBD	_____
2. Designer Contact	<input type="checkbox"/> Y <input type="checkbox"/> N <input type="checkbox"/> TBD	<input type="checkbox"/> Y <input type="checkbox"/> N <input type="checkbox"/> TBD	<input type="checkbox"/> Y <input type="checkbox"/> N <input type="checkbox"/> TBD	<input type="checkbox"/> Y <input type="checkbox"/> N <input type="checkbox"/> TBD	_____
3. COM Vendor contact	<input type="checkbox"/> Y <input type="checkbox"/> N <input type="checkbox"/> TBD	<input type="checkbox"/> Y <input type="checkbox"/> N <input type="checkbox"/> TBD	<input type="checkbox"/> Y <input type="checkbox"/> N <input type="checkbox"/> TBD	<input type="checkbox"/> Y <input type="checkbox"/> N <input type="checkbox"/> TBD	_____
4. Manufacturer's Project Coordinator	<input type="checkbox"/> Y <input type="checkbox"/> N <input type="checkbox"/> TBD	<input type="checkbox"/> Y <input type="checkbox"/> N <input type="checkbox"/> TBD	<input type="checkbox"/> Y <input type="checkbox"/> N <input type="checkbox"/> TBD	<input type="checkbox"/> Y <input type="checkbox"/> N <input type="checkbox"/> TBD	_____
5. Facility Manager or Site Representative	<input type="checkbox"/> Y <input type="checkbox"/> N <input type="checkbox"/> TBD	<input type="checkbox"/> Y <input type="checkbox"/> N <input type="checkbox"/> TBD	<input type="checkbox"/> Y <input type="checkbox"/> N <input type="checkbox"/> TBD	<input type="checkbox"/> Y <input type="checkbox"/> N <input type="checkbox"/> TBD	_____
6. Facility Address	<input type="checkbox"/> Y <input type="checkbox"/> N <input type="checkbox"/> TBD	<input type="checkbox"/> Y <input type="checkbox"/> N <input type="checkbox"/> TBD	<input type="checkbox"/> Y <input type="checkbox"/> N <input type="checkbox"/> TBD	<input type="checkbox"/> Y <input type="checkbox"/> N <input type="checkbox"/> TBD	_____

Name/Address	Comments	Name/Address	Comments
Step Two Define user needs			
1. Identified number of users per room?	<input type="checkbox"/> Y <input type="checkbox"/> N <input type="checkbox"/> TBD _____	1. New construction or existing?	<input type="checkbox"/> Y <input type="checkbox"/> N <input type="checkbox"/> TBD _____
2. Identified number of users per table?	<input type="checkbox"/> Y <input type="checkbox"/> N <input type="checkbox"/> TBD _____	2. Do we need a floor plan?	<input type="checkbox"/> Y <input type="checkbox"/> N <input type="checkbox"/> TBD _____
3. What functions do users need and what are they denied?		3. Do we have the key information for space access?	
Power	<input type="checkbox"/> Y <input type="checkbox"/> N <input type="checkbox"/> TBD _____	Doorway Dimensions	<input type="checkbox"/> Y <input type="checkbox"/> N <input type="checkbox"/> TBD _____
Data	<input type="checkbox"/> Y <input type="checkbox"/> N <input type="checkbox"/> TBD _____	Corridor Dimensions	<input type="checkbox"/> Y <input type="checkbox"/> N <input type="checkbox"/> TBD _____
Mobility	<input type="checkbox"/> Y <input type="checkbox"/> N <input type="checkbox"/> TBD _____	Loading Docks/Height	<input type="checkbox"/> Y <input type="checkbox"/> N <input type="checkbox"/> TBD _____
Access	<input type="checkbox"/> Y <input type="checkbox"/> N <input type="checkbox"/> TBD _____	Freight Elevators/Size/Restrictions	<input type="checkbox"/> Y <input type="checkbox"/> N <input type="checkbox"/> TBD _____
Change of use	<input type="checkbox"/> Y <input type="checkbox"/> N <input type="checkbox"/> TBD _____	Hours Available for Install	<input type="checkbox"/> Y <input type="checkbox"/> N <input type="checkbox"/> TBD _____
ADA	<input type="checkbox"/> Y <input type="checkbox"/> N <input type="checkbox"/> TBD _____	4. Will the space need to be reconfigurable?	<input type="checkbox"/> Y <input type="checkbox"/> N <input type="checkbox"/> TBD _____
Privacy	<input type="checkbox"/> Y <input type="checkbox"/> N <input type="checkbox"/> TBD _____	5. What is primary use for the space?	<input type="checkbox"/> Y <input type="checkbox"/> N <input type="checkbox"/> TBD _____
		6. Are casters required?	<input type="checkbox"/> Y <input type="checkbox"/> N <input type="checkbox"/> TBD _____
		7. Is there a need for carts?	<input type="checkbox"/> Y <input type="checkbox"/> N <input type="checkbox"/> TBD _____
		8. Is there a room configuration layout?	<input type="checkbox"/> Y <input type="checkbox"/> N <input type="checkbox"/> TBD _____
		9. Are drawings/plans current and approved?	<input type="checkbox"/> Y <input type="checkbox"/> N <input type="checkbox"/> TBD _____

Step Four Details for Product Specifications				Step Five Checkstep			
1. Table Tops				1. Does the product specification meet with the needs of the end users as specified above and if not, is the client aware of this?			
Shapes/Dimensions	<input type="checkbox"/> Y <input type="checkbox"/> N <input type="checkbox"/> TBD _____			<input type="checkbox"/> Y <input type="checkbox"/> N <input type="checkbox"/> TBD	_____		
Quantity	<input type="checkbox"/> Y <input type="checkbox"/> N <input type="checkbox"/> TBD _____			2. Have you reviewed Falcon's complementary seating products for these tables, such as Verona or Sienna?			
Top Surface Material	<input type="checkbox"/> Y <input type="checkbox"/> N <input type="checkbox"/> TBD _____			<input type="checkbox"/> Y <input type="checkbox"/> N <input type="checkbox"/> TBD	_____		
Edge Material	<input type="checkbox"/> Y <input type="checkbox"/> N <input type="checkbox"/> TBD _____			3. Do we have final sign off on specifications and are all of the key elements in place for			
Edge Profile	<input type="checkbox"/> Y <input type="checkbox"/> N <input type="checkbox"/> TBD _____			A successful installation			
Gangers/Placement Drawing	<input type="checkbox"/> Y <input type="checkbox"/> N <input type="checkbox"/> TBD _____			<input type="checkbox"/> Y <input type="checkbox"/> N <input type="checkbox"/> TBD	_____		
Connectors	<input type="checkbox"/> Y <input type="checkbox"/> N <input type="checkbox"/> TBD _____			Credit approved or deposit received			
2. Bases (Columns And Feet)				<input type="checkbox"/> Y <input type="checkbox"/> N <input type="checkbox"/> TBD _____			
Style	<input type="checkbox"/> Y <input type="checkbox"/> N <input type="checkbox"/> TBD _____			COM ship to address provided to vendor			
Are they appropriate for selected tops?	<input type="checkbox"/> Y <input type="checkbox"/> N <input type="checkbox"/> TBD _____			<input type="checkbox"/> Y <input type="checkbox"/> N <input type="checkbox"/> TBD	_____		
Finishes	<input type="checkbox"/> Y <input type="checkbox"/> N <input type="checkbox"/> TBD _____			COM materials received from vendor			
Collar Color	<input type="checkbox"/> Y <input type="checkbox"/> N <input type="checkbox"/> TBD _____			<input type="checkbox"/> Y <input type="checkbox"/> N <input type="checkbox"/> TBD	_____		
Any Weight Issues	<input type="checkbox"/> Y <input type="checkbox"/> N <input type="checkbox"/> TBD _____			Order acknowledgement been reviewed for accuracy			
ADA Requirements	<input type="checkbox"/> Y <input type="checkbox"/> N <input type="checkbox"/> TBD _____			<input type="checkbox"/> Y <input type="checkbox"/> N <input type="checkbox"/> TBD	_____		
3. Lower Modesty Panels and Privacy Screens				Pricing confirmed			
Dimensions	<input type="checkbox"/> Y <input type="checkbox"/> N <input type="checkbox"/> TBD _____			<input type="checkbox"/> Y <input type="checkbox"/> N <input type="checkbox"/> TBD	_____		
Materials	<input type="checkbox"/> Y <input type="checkbox"/> N <input type="checkbox"/> TBD _____			Terms agreed upon			
Edge Color	<input type="checkbox"/> Y <input type="checkbox"/> N <input type="checkbox"/> TBD _____			<input type="checkbox"/> Y <input type="checkbox"/> N <input type="checkbox"/> TBD	_____		
4. Power And Data Requirements - See ordering and power in this workbook, contact your sales representative or customer service for detailed assistance				Step Six Dates			
5. Other Options				1. Identify target delivery date			
Castors	<input type="checkbox"/> Y <input type="checkbox"/> N <input type="checkbox"/> TBD _____			<input type="checkbox"/> Y <input type="checkbox"/> N <input type="checkbox"/> TBD	_____		
Table Trucks	<input type="checkbox"/> Y <input type="checkbox"/> N <input type="checkbox"/> TBD _____			2. Identify target installation date			
Optional Wire Galleries	<input type="checkbox"/> Y <input type="checkbox"/> N <input type="checkbox"/> TBD _____			<input type="checkbox"/> Y <input type="checkbox"/> N <input type="checkbox"/> TBD	_____		
6. Are there any unusual requirements which may delay the project? Is the client aware of this potential?				3. Identify target completion date			
<input type="checkbox"/> Y <input type="checkbox"/> N <input type="checkbox"/> TBD _____			<input type="checkbox"/> Y <input type="checkbox"/> N <input type="checkbox"/> TBD	_____			

ORDERING INFORMATION

Visit falconproducts.com for Terms and Conditions.

SPECIFY THE FOLLOWING	PORTABLE TABLES - FOLDING (20FC/20FS)	FREESTANDING TABLES (20TC/20TS)	SHARED LEG TABLES (41S/42A)	SCREEN GROUPS
Standard Features				
Quantity	•	•	•	•
Catalog Number	•	•	•	•
Dimensions: Length, Width, Height (if applicable)	•	•	•	•
Edge Color/Finish	•	•	•	•
Wood Edge Species*		•		
Laminate **	•	•	•	•
Metal Finish	•	•	•	
Accent Collar Color	•	•	•	
Optional Accessories				
WM1 Wire Modesty Gallery	•	•		
Electrical	•	•	•	
Lift Mechanism		•		
Adjustable Height Option		•		
Connectors	•	•		
Gangers - Include Placement Drawings	•	•		
Upper Modesty Panel	•	•		
Cable Clip	•	•	•	
Tilt Truck	•			
Casters	•	•		
Grommets	•	•		

*Wood edges standard in Maple. Other species available, call for quote.

**Laminate: Manufacturer, pattern, color and number

All Products FOB: Newport, TN

Small Order Charge

Orders with a combined Net price under \$1,000 will be subject to a Special Handling Charge of \$125 Net. One charge per order.

NOTE • Please see back cover for complementary seating products.

MATS POWER SOLUTIONS

DEFINE YOUR APPLICATION

We have a variety of power solutions appropriate for any of your power requirements. Please take a moment to evaluate your project and complete the following check list. It will help determine which power solution best fits your needs. After you have answered these questions, contact your sales representative, or customer service representative, who will assist you with the specific details for adding the power option to your table order.

My client is powering more than one table (Y/N)

- _____ Our plan calls for less than 16 users per row
- _____ I need data brought into the tables
- _____ I need power at the top surface
- _____ I need power accessible below the table for CPU's to plug into
- _____ The room is permanent and will not be reconfigured
- _____ The room will have bolt down tables
- _____ Power is currently available in the wall
- _____ Power is currently available in the floor
- _____ New construction, power can be located anywhere
- _____ What is the desired table length
- _____ How many users per table

What will be plugged into each table:

- _____ Number of Computers
- _____ Number of Monitors
- _____ Number of Printers or other equipment
- _____ Does the building have 15 amp power available (Y/N)
- _____ Does the building have 20 amp power available (Y/N)

SOLUTIONS

I. Simple Power

Simple power is defined as a 15 amp plug that is inserted into a standard outlet. Each electrical component in the table would plug directly into the floor or wall. This power is commonly used with conference tables or very small training rooms.

II. Table Top Daisy Chain Power

This power allows you run rows of tables in a training room. Up to 16 users can generally be provided with power from one access point. If there are more than 16 users, additional access points must be designated. The type of power can be applied using one of the following options.

- a. Interlink:**
- i. 12 amp system rating with 15 amp power cord.
 - ii. Up to 8 duplexes devices such as Miniports.
 - iii. Meets UL 962.

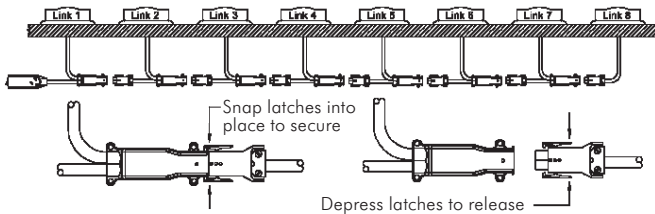

- b. Interconnect:**
- i. 8 wire, 4-circuit system or 4 wire 2 circuit system depending on power need.
 - ii. 20 amp system rating.
 - iii. UL 183.
 - iv. Must be hard wired to the building or utilize quick connect.
 - v. Building must be wired for 20 amp rating.

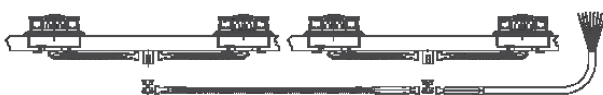

III. Fully Integrated Power within the Wire Manager and Table Top

This solution allows for computer rooms to power a CPU, monitor, printer, etc. from underneath the table surface as well as power other ancillary equipment from the top surface. It allows for long runs of power with the ability to segregate for clean circuits.

- i. 20 amp single circuit solution that utilizes a 20 amp plug.
- ii. 2 circuit system that is rated at 20 amps per circuit or a total of 40 amps which requires hardwiring to the building.
- iii. 4 circuit system that is rated at 20 amps per circuit or a total of 80 amps which requires hardwiring to the building.
- iv. UL1286 rated.
- v. Building must be wired for 20 amp rating.



Information is for planning purpose only. Contact a licensed electrician to ensure required building codes are met.

EDGES AND COLORS Table Edges and Laminates

EDGE PROFILES



4720

- Clean sloped post form laminate edge
- 1 1/4" thick top
- Sloped edge on user side, other three edges flat PVC
- Flat edges allow tables to be ganged
- Perfect for high use applications
- Wide variety of standard laminate options
- Special laminates also available
- Suitable for use with divider screens



4150/4157

- Urethane sloped edge (user side)
- 2 1/2" X 1 1/4"
- 4160/4167 flat urethane edge on other three sides
- Flat sides allow tables to be ganged
- Extremely durable edge for high use applications
- Suitable for use with divider screens
- Five standard color options
- Variety of additional color options available



4160/4167

- Flat urethane edge
- 1/4" X 1 1/4"
- Extremely durable
- Flat edge allows tables to be ganged
- Variety of additional color options available

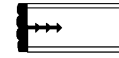

1350

- Vinyl T mold
- 1/4" X 1 1/4"
- Decorative ribbed profile
- Low cost alternative
- Flat profile allows tables to be ganged
- Variety of additional color options available

MOST POPULAR EDGE COLORS

Color Name	Code
Bark	41
Black	1
Dark Grey	23
Graphite	42
Light Grey	12



Bark



Black



Dark Grey



Graphite



Light Grey

To view all available colors for each edge, visit falconproducts.com

4720 POSTFORM LAMINATE TOPS

Laminate - Grade 1 (standard) Normal Lead Times

The following laminates are available for 4720 Postform tops in standard lead time. For lead times on additional laminate choices, contact sales or customer service, 423-623-0031.

Formica

- FO515 Graphite Grafix
- FO912 Storm
- FO503 Stone Grafix
- FO961 Fog
- FO507 Folkstone Grafix
- FO920 Almond
- FO5904 Wild Cherry
- FO756 Natural Maple

TABLE SURFACE LAMINATE

Listed below are our most popular laminates, which are available at standard pricing and lead times.

Formica

- Solid Color Portfolio (Matte Finish)
- Patterns
- Formations Collection
- Woodgrains

If you would like to see an expanded offering, please visit Formica's web site at formica.com.

You may also call Formica at **1-800-FORMICA** for samples.

Should you require additional options, see selections at nevamar.com and wilsonartcontract.com. When you have made your selections, contact sales or customer service for pricing and lead time assistance. If the pricing or lead times are not to your satisfaction, we will be happy to help you reselect.

If your project requires something more unique, we can provide laminate from any manufacturer, including custom laminates. Please contact sales or customer service for assistance with pricing, lead times, and minimum order requirements.

EDGES AND COLORS Finishes

WOOD EDGE PROFILE



2300

- Maple species wood edge
- 1/4" X 1 1/4"
- Flat profile allows tables to be ganged
- Available in any standard wood finish
- Optional custom finishes also available
- Additional wood species also available

WOOD FINISHES

Standard Woodtone	Code
Natural	WBF110
Golden	WBF112
Medium Oak	WBF122
Chestnut	WBF124
Medium Brown Mahogany	WBF126
Dark Walnut	WBF128
Light Cherry	WBF131
Amber Cherry	WBF134
Royal Mahogany	WBF136
Black	WBF154

- Standard Finish (lacquer) is WBF wood finish with semi-gloss lacquer. No upcharge.
- Wood finishes will vary due to inconsistencies in lumber and moisture; therefore we assume no responsibility for matches to exact tones. When matching the laminate patterns containing large variations in color, stain will be matched with harmonizing tone.
- Custom finishes and color matches are available with an upcharge. Sample of finish will be required for matching prior to production. Should matching require brushing, glazing, or hand wiping additional charges may apply. Factory may require a sample before quoting. See WBF Wood Finishes swatchcard for sample of finishes.

METAL FINISHES: POWDERCOAT

Powdercoat Colors	Polished Casting
Fog	CP012S
Matte Black	CP001MS
Storm	CP023S

- All tables are priced in any Grade 3 powdercoat
- See finish card or visit falconproducts.com for additional standard and nonstandard color choices

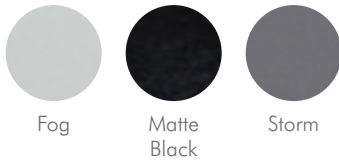

Shown with 1350 Series edge in Black, laminate top in Almond, and legs in Matte Black finish.

FALCON™

SPECTRA™ TABLES

WORKBOOK/PRICE LIST August 2015

DELIVERED TO ZONE 1, ADD + 4% DELIVERED TO ZONE 2



SQUARE TABLES
SP3F ROUND LEG
SP4F SQUARE LEG

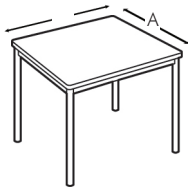

Table Size A x B	Apprx WT	1446	2326	Veneer Upcharge	Polished Chrome Upcharge
30 x 30	51	949	1,319	242	111
36 x 36	66	1,000	1,524	347	111
42 x 42	81	1,095	1,811	473	111
48 x 48	96	1,151	2,066	617	111

RECTANGULAR TABLES
SP3F ROUND LEG
SP4F SQUARE LEG

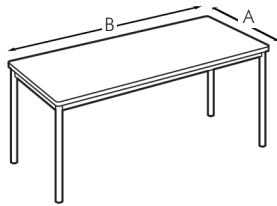
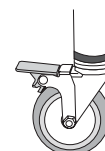

Table Size A x B	Apprx WT	1446	2326	Veneer Upcharge	Polished Chrome Upcharge
18 x 60	61	996	1,352	290	111
18 x 72	68	1,056	1,432	347	111
18 x 84	75	1,154	1,820	405	111
18 x 96	82	1,218	1,885	463	111
24 x 48	66	996	1,322	309	111
24 x 60	76	1,039	1,441	385	111
24 x 72	86	1,099	1,589	463	111
24 x 84	96	1,151	1,814	540	111
24 x 96	106	1,258	1,885	617	111
30 x 36	71	1,027	1,306	290	111
30 x 48	82	1,031	1,360	385	111
30 x 60	93	1,099	1,512	482	111
30 x 72	104	1,158	1,597	579	111
30 x 84	115	1,337	1,903	675	111
30 x 96	126	1,376	2,002	772	111
36 x 48	84	1,056	1,441	463	111
36 x 60	96	1,129	1,632	579	111
36 x 72	108	1,183	1,724	694	111
36 x 84	124	1,269	1,983	811	111
36 x 96	133	1,327	2,185	927	111

NOTES

- Standard Grade 1 Laminate and any Grade 3 Powdercoat.
- Wood edges standard in Maple. Other species available, call for pricing.
- All prices are list delivered to Zone 1. Add 4% for Zone 2.
- Standard table height: 29"



For added mobility specify the Spectra castor and add \$148 list per table. The set of four casters does not change the height of the table and must be factory installed.

STATIONARY

TRAPEZOID TABLES

SP3F ROUND LEG

SP4F SQUARE LEG

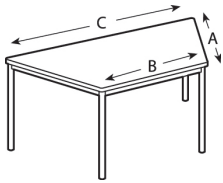

Table Size A x B x C	Apprx WT	1446	2326	Veneer Upcharge	Polished Chrome Upcharge
24 x 24 x 48	54	1,189	1,584	309	111
30 x 30 x 60	86	1,337	1,795	482	111
36 x 36 x 72	118	1,413	2,092	694	111

TRUNCATED TRIANGLE TABLES

SP3F ROUND LEG

SP4F SQUARE LEG

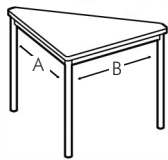

Table Size A x B	Apprx WT	1446	2326	Veneer Upcharge	Polished Chrome Upcharge
24 x 24	34	781	1,272	155	111
30 x 30	44	833	1,314	242	111
36 x 36	54	907	1,344	347	111

QUARTER ROUND TABLES

SP3F ROUND LEG

SP4F SQUARE LEG

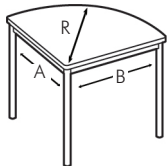

Table Size R x A/B	Apprx WT	1446	2326	Veneer Upcharge	Polished Chrome Upcharge
24 x 24	36	790	1,314	155	111
30 x 30	46	867	1,485	242	111
36 x 36	56	1,000	2,082	347	111

STATIONARY

HALF ROUND TABLES
SP3F ROUND LEG
SP4F SQUARE LEG

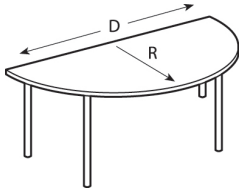

Table Size R x D	Apprx WT	1446	2326	Veneer Upcharge	Polished Chrome Upcharge
24 x 48	59	1,189	1,890	309	111
30 x 60	91	1,306	2,377	482	111
36 x 72	123	1,441	2,813	694	111

ROUND TABLES
SP3F ROUND LEG
SP4F SQUARE LEG

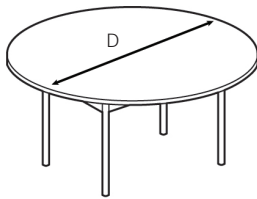

Table Size D	Apprx WT	1446	2326	Veneer Upcharge	Polished Chrome Upcharge
36	70	1,344	1,867	347	111
42	85	1,432	2,146	540	111
48	103	1,502	2,417	617	111

FOLDING

SQUARE TABLES
SP5F ROUND LEG
SP6F SQUARE LEG

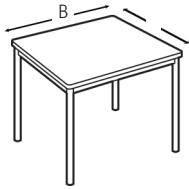

Table Size A x B	Apprx WT	1446	2326	Polished Chrome Upcharge
36 x 36	70	1,344	1,867	111
42 x 42	85	1,432	2,146	111
48 x 48	103	1,502	2,417	111

RECTANGLE TABLES
SP5F ROUND LEG
SP6F SQUARE LEG

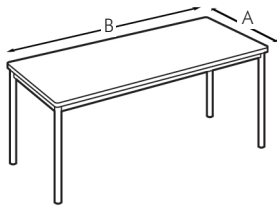
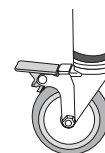

Table Size A x B	Apprx WT	1446	2326	Polished Chrome Upcharge
18 x 60	65	1,241	1,593	111
18 x 72	72	1,300	1,676	111
18 x 84	79	1,405	2,072	111
18 x 96	86	1,474	2,140	111
24 x 48	70	1,254	1,609	111
24 x 60	80	1,290	1,689	111
24 x 72	90	1,352	1,792	111
24 x 84	100	1,438	2,086	111
24 x 96	110	1,569	2,174	111
30 x 36	75	1,241	1,555	111
30 x 48	86	1,300	1,637	111
30 x 60	97	1,337	1,758	111
30 x 72	108	1,405	1,867	111
30 x 84	119	1,628	2,189	111
30 x 96	130	1,668	2,249	111
36 x 48	88	1,356	1,740	111
36 x 60	100	1,424	1,931	111
36 x 72	112	1,477	2,023	111
36 x 84	125	1,555	2,270	111
36 x 96	137	1,632	2,490	111

NOTES

- Spectra Folding Tables not available in Veneer.
- Standard Grade 1 Laminate and any Grade 3 Powdercoat.
- Wood edges standard in Maple. Other species available, call for pricing.
- All prices are list delivered to Zone 1. Add 4% for Zone 2.
- Standard table height: 29"



For added mobility specify the Spectra caster and add \$148 list per table. The set of four casters does not change the height of the table and must be factory installed.

FOLDING

TRAPEZOID TABLES

SP5F ROUND LEG

SP6F SQUARE LEG

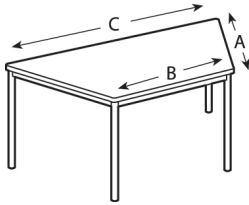

Table Size A x B x C	Apprx WT	1446	2326	Polished Chrome Upcharge
24 x 24 x 48	58	1,507	1,903	111
30 x 30 x 60	90	1,665	2,120	111
36 x 36 x 72	122	1,758	2,434	111

HALF ROUND TABLES

SP5F ROUND LEG

SP6F SQUARE LEG

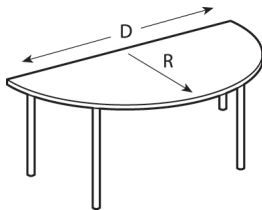

Table Size R x D	Apprx WT	1446	2326	Polished Chrome Upcharge
24 x 48	63	1,519	2,258	111
30 x 60	95	1,654	2,727	111
36 x 72	127	1,811	3,180	111

ROUND TABLES

SP5F ROUND LEG

SP6F SQUARE LEG

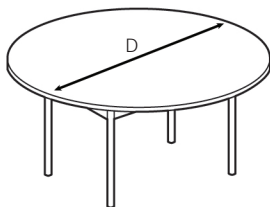
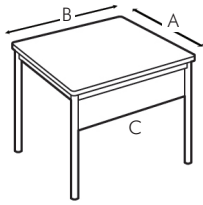

Table Size D	Apprx WT	1446	2326	Polished Chrome Upcharge
48	80	1,497	2,092	111
54	105	1,519	2,596	111
60	130	1,539	2,623	111

TRAINING STATIONARY

SQUARE TABLES
SP3FA ROUND LEG
SP4FA SQUARE LEG



Wood Edges Only

Table Size A x B	Apprx WT	1446	2326	Veneer Upcharge	Polished Chrome Upcharge
30 x 30	51	1,189	1,555	337	111
36 x 36	66	1,246	1,766	463	111
42 x 42	81	1,344	2,059	608	111
48 x 48	96	1,424	2,342	772	111

Modesty on C side

RECTANGLE TABLES
SP3FA ROUND LEG
SP4FA SQUARE LEG

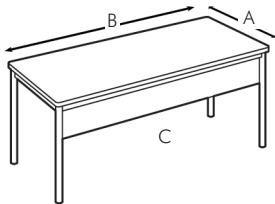

Wood Edges Only

Table Size A x B	Apprx WT	1446	2326	Veneer Upcharge	Polished Chrome Upcharge
18 x 60	61	1,290	1,641	482	111
18 x 72	68	1,376	1,750	579	111
18 x 84	75	1,644	2,314	675	111
18 x 96	82	1,709	2,374	772	111
24 x 48	66	1,241	1,597	463	111
24 x 60	76	1,337	1,740	579	111
24 x 72	86	1,420	1,858	694	111
24 x 84	96	1,641	2,292	811	111
24 x 96	106	1,771	2,377	927	111
30 x 36	71	1,241	1,555	405	111
30 x 48	82	1,290	1,628	540	111
30 x 60	93	1,392	1,811	714	111
30 x 72	104	1,459	1,920	811	111
30 x 84	115	1,814	2,377	945	111
30 x 96	126	1,867	2,490	1,080	111
36 x 48	84	1,334	1,716	617	111
36 x 60	96	1,424	1,931	772	111
36 x 72	108	1,502	2,045	927	111
36 x 84	124	1,747	2,460	1,080	111
36 x 96	133	1,811	2,669	1,235	111

Modesty on C side

NOTES

- Standard Grade 1 Laminate and any Grade 3 Powdercoat.
- Wood edges standard in Maple. Other species available, call for pricing.
- All prices are list delivered to Zone 1. Add 4% for Zone 2.
- Standard table height: 29"

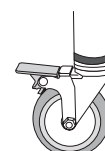

For added mobility specify the Spectra caster and add \$148 list per table. The set of four casters does not change the height of the table and must be factory installed.

TRAINING STATIONARY

TRAPEZOID TABLES
SP3FA ROUND LEG
SP4FA SQUARE LEG

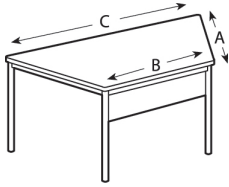

Table Size A x B x C	Apprx WT	1446	2326	Veneer Upcharge	Polished Chrome Upcharge
24 x 24 x 48	54	1,494	1,885	385	111
30 x 30 x 60	86	1,659	2,115	579	111
36 x 36 x 72	118	1,724	2,401	811	111

Modesty on B side

TRAPEZOID TABLES
SP3FA ROUND LEG
SP4FA SQUARE LEG

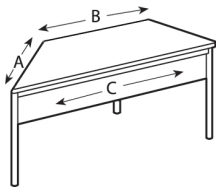

Table Size A x B x C	Apprx WT	1446	2326	Veneer Upcharge	Polished Chrome Upcharge
24 x 24 x 48	54	1,726	2,123	463	111
30 x 30 x 60	86	1,894	2,352	675	111
36 x 36 x 72	118	1,963	2,637	927	111

Modesty on C side

TRUNCATED TRIANGLE TABLES
SP3FA ROUND LEG
SP4FA SQUARE LEG

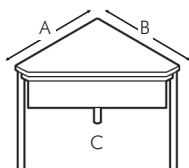

Table Size A x B	Apprx WT	1446	2326	Veneer Upcharge	Polished Chrome Upcharge
24 x 24	34	993	1,800	231	111
30 x 30	44	1,060	2,314	337	111
36 x 36	54	1,139	2,749	463	111

Modesty on C side

TRAINING STATIONARY

QUARTER ROUND TABLES

SP3FA ROUND LEG

SP4FA SQUARE LEG

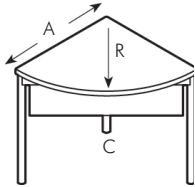

Wood Edges Only

Table Size R x A	Apprx WT	1446	2326	Veneer Upcharge	Polished Chrome Upcharge
24 x 24	36	1,039	1,561	231	111
30 x 30	46	1,134	1,750	337	111
36 x 36	56	1,269	2,349	463	111

Modesty on C side

SP3FA HALF ROUND TABLES

SP3FA ROUND LEG

SP4FA SQUARE LEG

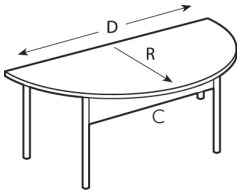

Wood Edges Only

Table Size R x D	Apprx WT	1446	2326	Veneer Upcharge	Polished Chrome Upcharge
24 x 48	59	1,494	2,196	463	111
30 x 60	91	1,632	2,705	675	111

Modesty on C side

TRAINING FOLDING

**SQUARE TABLE
SP5FA ROUND LEG
SP6FA SQUARE LEG**

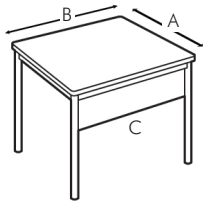

Table Size A x B	Apprx WT	1446	2326	Polished Chrome Upcharge
36 x 36	66	1,609	2,129	111
42 x 42	81	1,703	2,417	111
48 x 48	96	1,792	2,705	111

Modesty on C side

**RECTANGLE TABLE
SP5FA ROUND LEG
SP6FA SQUARE LEG**

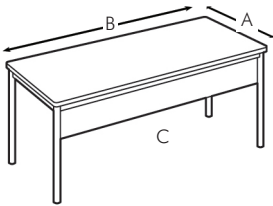

Table Size A x B	Apprx WT	1446	2326	Polished Chrome Upcharge
18 x 60	61	1,539	1,890	111
18 x 72	68	1,622	1,997	111
18 x 84	75	1,885	2,555	111
18 x 96	82	1,956	2,620	111
24 x 48	66	1,593	1,997	111
24 x 60	76	1,641	2,115	111
24 x 72	86	1,724	2,205	111
24 x 84	96	1,895	2,551	111
24 x 96	106	2,016	2,623	111
30 x 36	71	1,494	1,805	111
30 x 48	82	1,577	1,915	111
30 x 60	93	1,676	2,059	111
30 x 72	104	1,852	2,185	111
30 x 84	115	2,101	2,669	111
30 x 96	126	2,115	2,737	111
36 x 48	84	1,637	2,023	111
36 x 60	96	1,728	2,233	111
36 x 72	108	1,805	2,349	111
36 x 84	124	2,037	2,754	111
36 x 96	133	2,126	2,980	111

Modesty on C side

NOTES

- Spectra Folding Tables not available in Veneer.
- Standard Grade 1 Laminate and any Grade 3 Powdercoat.
- Wood edges standard in Maple. Other species available, call for pricing.
- All prices are list delivered to Zone 1. Add 4% for Zone 2.
- Standard table height: 29"



For added mobility specify the Spectra caster and add \$148 list per table. The set of four casters does not change the height of the table and must be factory installed.

TRAINING FOLDING

TRAPEZOID TABLE SP5FA ROUND LEG SP6FA SQUARE LEG

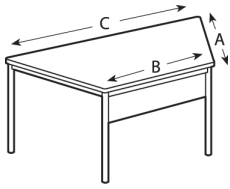

Table Size A x B x C	Apprx WT	1446	2326	Polished Chrome Upcharge
24 x 24 x 48	54	1,829	2,258	111
30 x 30 x 60	86	2,006	2,460	111
36 x 36 x 72	118	2,108	2,788	111

Modesty on B side

TRAPEZOID TABLE SP5FA ROUND LEG SP6FA SQUARE LEG

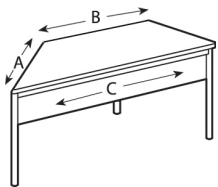

Table Size A x B x C	Apprx WT	1446	2326	Polished Chrome Upcharge
24 x 24 x 48	54	2,065	2,458	111
30 x 30 x 60	86	2,242	2,698	111
36 x 36 x 72	118	2,347	3,023	111

Modesty on C side

HALF ROUND TABLE SP5FA ROUND LEG SP6FA SQUARE LEG

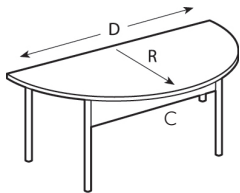

Table Size R x D	Apprx WT	1446	2326	Polished Chrome Upcharge
24 x 48	59	1,820	2,524	111
30 x 60	91	1,971	3,046	111
36 x 72	123	2,129	3,503	111

Modesty on C side



TKCEG

- \$1,637
- Recommended for tables up to 96" long
- Carpet over plywood

SPECIFICATIONS

HOW TO ORDER

When ordering please specify:

1. Model Number & Edge Selection Number
2. Quantity
3. Shape
4. Size
5. Base Finish
6. Top Selection (laminite pattern number and description, veneer finish number and description)
7. Edge Finish Selection (specify wood finish and species if ordering wood edges)
8. Options
9. Small Order Charge: Orders with a combined Net price under \$1,000 will be subject to a Special Handling Charge of \$125 Net. One charge per order.

EDGE PROFILES



1446
7/8" laminate top banded with flat PVC molding. No radius at corners.



2326
7/8" laminate top banded with 1/4" hardwood. No radius at corners.



2326 Veneer
7/8" Veneer top banded with 1/4" hardwood. No radius at corners. Not recommended on Folding Tables.



MODESTY PANEL TRAINING TABLES

- Construction, edge shape and color selection same as for top.
- 8" high
- Panel folds up and locks out of view, allowing for seating on modesty panel side of table.
- On folding rectangular tables, modesty panel can remain attached when table is folded.
- On folding trapezoid tables, the modesty panel slides out of hinge brackets for removal before table is folded.

GANGING MECHANISM

- All tables can be ganged along any straight side.
- Spring steel clamps fold out from the underside of the table.
- Clamps hook onto the back side of the stretcher of an adjacent table.
- All tables come standard with ganging mechanisms, except round.

GROMMETS

- Provides wire access through table top.
- Black plastic with snap-on covers.
- Two grommets installed per table.



970801 - Round

- \$108 a pair
- Size: 2-5/16" Diameter (inside dimensions).
- Standard side location: 3-9/16" from back edge and 6-1/8" from each end.
- Standard center location: 2-7/8" from back edge and center of table length.
- Single location must be specified, left, right, or center, using above dimensions for placement.



970812 - Oval

- \$114 a pair
- Size: 2-5/8" x 3-1/8" (inside dimensions).
- Standard location: 3-5/16" from back edge and 6-1/8" from each end.
- Standard center location: 3-5/16" from back edge and center of table length.
- Single location must be specified, left, right, or center, using above dimensions for placement.

Power and data options available. Call for pricing.

UNDERSTRUCTURE CONSTRUCTION



Round



Square

Legs and Stretchers

- Made from 1-1/2" diameter 16 gauge steel tubing with steel reinforcing plugs. Available in Square or Round Tubing.
- Black adjustable glides.
- Stretchers 2" high x 1" deep 17 gauge rectangular steel tubing.
- Legs and stretchers finished in same color selection.
- Finished with Powdercoat or Chrome. See color chart for finish selection.
- Clearance from floor to bottom of stretcher is 26".



SPECTRA CASTER

- The set of four casters does not change the height of the table and must be factory installed.

SPECTRA GLIDES

- Four glides per table.
- Black nylon with threaded stem.
- 1 1/2" diameter.
- Glide provides 1" adjustment of table.

SHIPPING

- Tables are shipped knocked down except for folding tables
- Accessories are packaged separately



Stationary Base

- Top is supported by 2" x 1" rectangular steel stretchers welded together into a one piece frame and fastened with #14 x 3/4" screws.
- Legs fasten to the corners of the frame with 5/16-18 x 1-1/4" bolts (2 per leg).



Folding Base

- Top is supported by 2" x 1" rectangular steel stretchers and fastened with #14 x 3/4" screws.
- Legs are joined together in pairs with similar 2" x 1" stretchers.
- The folding mechanism is a camlock design permitting operation of one pair of legs at a time.
- A lever locks the legs in both the folded and unfolded positions.
- When folded, the legs stack on top of the stretchers.
- Folded thickness: 5-7/8" (4-3/8" for rectangular tables 60" and longer).



DELUXE TRUCKS

- Eliminates the need for two person handling.
- Saves wear and tear on designer tables.

SPECIFICATIONS

- Quiet, smooth movement on 6" diameter vulcanized rubber tired roller bearing casters.
- Load capacity 2,000 lbs.— up to six tables
- Finish is black enamel with carpeted bed and horizontal rails
- Packed Weight: 115 lbs.
- 30"W x 42"L x 34"D
- Allowable total depth of tables: 26"

FINISHES

Additional standard and optional finishes available at falconproducts.com

Wood Colors



Metal Powdercoat Colors

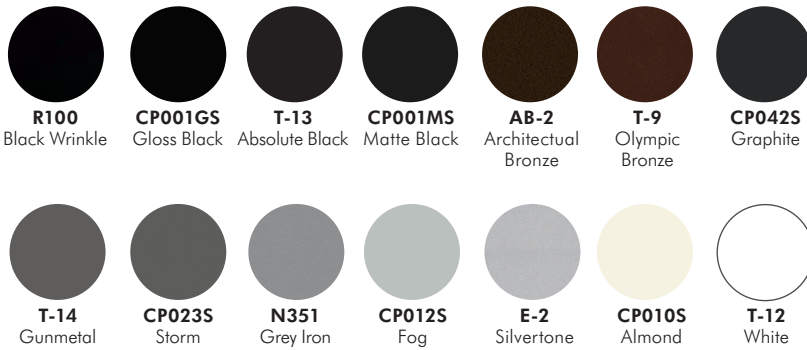

Vinyl Edges Colors Available on 1446 Edge Profile

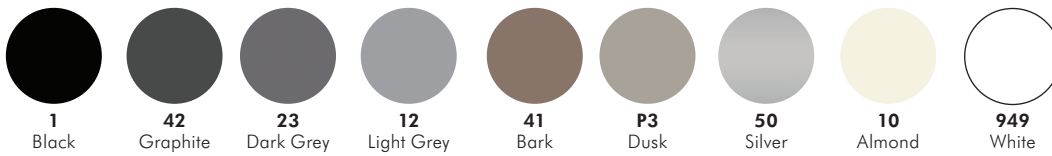

SP4F Square Leg Stationary Table

FALCON™

STORM™ TABLES

WORKBOOK/PRICE LIST August 2015

DELIVERED TO ZONE 1, ADD + 4% DELIVERED TO ZONE 2



STORM™ Easy to Move. Built to Last.



CONTENTS

Tables

Stationary	56
Flip top	61
Folding	67
Bridges	71
Adjustable Height	72

Specifications & Trucks	74
------------------------------------	----

Options	76
----------------	----

Finishes	78
-----------------	----



Optional integrated wheels shown on cantilever leg



45° struts provide strength to folding mechanism

STATIONARY

ST3TC OR ST3CC
CLAMP ON
MODESTY PANEL

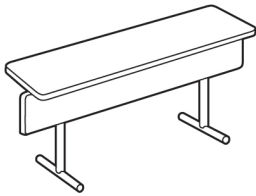

Table Size A x B	Apprx WT	Base Style	1300/ 1333/ 1340/ 1440	1444/ 2323	2405/ 2420	2344	4720	4150	Polished Chrome Upcharge	Welded Base Upcharge	Veener Upcharge
18 x 48	87	14C	941	1,013	1,299	1,148	1,068	1,438	109	48	385
18 x 60	94	14C	989	1,130	1,438	1,263	1,172	1,529	109	48	482
18 x 72	101	14C	1,059	1,204	1,554	1,339	1,287	1,678	109	48	579
18 x 90	110	14C	1,403	1,609	2,204	1,745	1,729	N/A	109	48	724
24 x 48	98	18T or C	951	1,098	1,399	1,231	1,082	1,449	109	48	463
24 x 60	108	18T or C	1,036	1,216	1,561	1,348	1,219	1,541	109	48	579
24 x 72	118	18T or C	1,140	1,318	1,706	1,453	1,365	1,689	109	48	694
24 x 90	135	18T or C	1,495	1,723	2,282	1,852	1,825	N/A	109	48	868
30 x 48	118	24T	999	1,134	1,444	1,268	1,157	1,632	109	48	540
30 x 60	131	24T	1,115	1,290	1,659	1,424	1,324	1,758	109	48	675
30 x 72	142	24T	1,201	1,388	1,800	1,522	1,446	1,966	109	48	811
30 x 90	176	24T	1,659	1,776	2,356	1,913	2,024	N/A	109	48	1,013

- **ST3TC**- Symmetrical end base
- **ST3CC**- Cantilever end base
- First two numbers of base style is base dimension
- Veneer available only on: 2323, 2344, 2405, 2420

ST3TA OR ST3CA
FOLDING
MODESTY PANEL

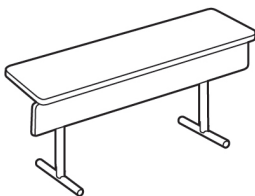

Table Size A x B	Apprx WT	Base Style	1300/ 1333/ 1340/ 1440	1444/ 2323	2405/ 2420	2344	4720	4150	Polished Chrome Upcharge	Welded Base Upcharge	Veener Upcharge
24 x 48	98	18T or C	1,102	1,251	1,549	1,382	1,232	1,598	109	48	463
24 x 60	108	18T or C	1,185	1,366	1,712	1,501	1,370	1,541	109	48	579
24 x 72	118	18T or C	1,419	1,596	1,982	1,729	1,643	1,841	109	48	694
24 x 90	135	18T or C	1,772	2,002	2,560	2,135	2,126	N/A	109	48	868
30 x 48	118	18T	1,153	1,286	1,592	1,420	1,310	1,784	109	48	540
30 x 60	131	24T	1,268	1,444	1,809	1,575	1,475	1,909	109	48	675
30 x 72	142	24T	1,479	1,666	2,080	1,800	1,725	2,118	109	48	811
30 x 90	176	24T	1,936	2,057	2,634	2,189	2,329	N/A	109	48	1,013

- **ST3TA**- Symmetrical end base
- **ST3CA**- Cantilever end base
- First two numbers of base style is base dimension
- Veneer available only on: 2323, 2344, 2405, 2420



STORM WHEEL OPTION

For added mobility specify the Storm Wheel and add \$135 per table. The Storm Wheel replaces one pair of end caps in an end base table up to 96" in length and facilitates easy movement for reconfiguring tables – merely pick up one end of the table and move.

STATIONARY

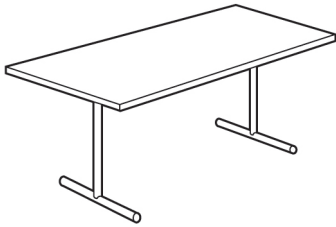

ST3T OR ST3C RECTANGULAR

Table Size A x B	Apprx WT	Base Style	1300/ 1333/ 1340/ 1440	1444/ 2323	2405/ 2420	2344	4720	4150	Polished Chrome Upcharge	Welded Base Upcharge	Veener Upcharge
18 x 48	51	14T or C	667	742	1,029	874	796	1,134	109	48	231
18 x 60	58	14T or C	687	827	1,134	960	871	1,225	109	48	290
18 x 72	65	14T or C	726	874	1,220	1,008	953	1,376	109	48	347
18 x 90	76	14T or C	1,042	1,248	1,841	1,380	1,369	N/A	109	48	434
24 x 48	64	18T or C	679	826	1,125	960	809	1,147	109	48	309
24 x 60	73	18T or C	733	912	1,260	1,047	917	1,238	109	48	385
24 x 72	82	18T or C	806	986	1,372	1,118	1,034	1,389	109	48	463
24 x 90	97	18T or C	1,133	1,361	1,921	1,494	1,460	N/A	109	48	579
30 x 48	74	24T	728	863	1,169	996	886	1,330	109	48	385
30 x 60	86	24T	816	989	1,356	1,121	1,021	1,456	109	48	482
30 x 72	98	24T	869	1,055	1,468	1,190	1,113	1,664	109	48	579
30 x 90	115	24T	1,294	1,413	1,997	1,549	1,664	N/A	109	48	724
36 x 48	83	24T	789	950	1,263	1,084	968	1,411	109	48	463
36 x 60	98	24T	855	1,044	1,497	1,174	1,103	1,664	109	48	579
36 x 72	112	24T	923	1,090	1,609	1,223	1,217	1,845	109	48	694
36 x 90	133	24T	1,364	1,595	2,108	1,728	1,825	N/A	109	48	868
42 x 84	163	32TT	1,590	1,663	2,322	1,797	2,204	N/A	163	48	945
42 x 96	180	32TT	1,600	1,705	2,475	1,836	2,214	N/A	163	48	1,080
48 x 96	199	38TT	1,644	1,761	2,518	1,891	N/A	N/A	163	48	1,235
48 x 120	262	38TT (3) Legs	2,059	2,220	3,061	2,353	N/A	N/A	216	48	1,544
48 x 144*	299	38TT (3) Legs	2,213	2,415	3,334	2,547	N/A	N/A	216	48	1,851
60 x 120	309	38TT (3) Legs	2,228	2,415	3,281	2,547	N/A	N/A	216	48	1,929
60 x 144*	356	38TT (3) Legs	2,408	2,638	3,579	2,773	N/A	N/A	216	48	2,314

* Tables 144" or longer ship in two pieces

- **ST3T**- Symmetrical end base
- **ST3C**- Cantilever end base
- First two numbers of base style is base dimension
- "TT" in base number represents two column -end base
- Veneer available only on: 2323, 2344, 2405, 2420

NOTES

- Standard Grade 1 Laminate and any Grade 3 Powdercoat.
- Wood edges standard in Maple. Other species available, call for pricing.
- All prices are list delivered to Zone 1. Add 4% for Zone 2.
- Standard table height: 28 3/4"
- Shipped knocked down



STORM WHEEL OPTION

For added mobility specify the Storm Wheel and add \$135 per table. The Storm Wheel replaces one pair of end caps in an end base table up to 96" in length and facilitates easy movement for reconfiguring tables – merely pick up one end of the table and move.

STATIONARY

- Grade 3 powdercoat, Grade 1 laminate, standard wood finish
- Several optional power solutions available

**ST3X
ROUND PEDESTAL BASE**



Wood Edges Only



Table Size	Apprx WT	Bases	Base Size	1300 / 1333 1340 / 1440	1444 / 2323	2405 / 2420	2344	4150	Polished Chrome Upcharge	Welded Base Upcharge	Veneer Upcharge
30 Round	42	1	26S	670	816	1,336	949	N/A	109	48	242
36 Round	52	1	26S	715	891	1,428	1,020	N/A	109	48	347
42 Round	65	1	32S-3	899	1,118	1,656	1,255	N/A	109	48	473
48 Round	79	1	32S-3	918	1,158	1,713	1,293	2,110	109	48	617
54 Round	125	1	38Q	1,324	1,636	2,522	1,770	N/A	163	N/A	781
60 Round	142	1	38Q	1,338	1,676	2,553	1,811	2,975	163	N/A	965



- ST3X- Pedestal Base

**ST3X
SQUARE PEDESTAL BASE**



Wood Edges Only



Table Size A x B	Apprx WT	Bases	Base Size	1300 / 1333 1340 / 1440	1444 / 2323	2405 / 2420	2344	Polished Chrome Upcharge	Welded Base Upcharge	Veneer Upcharge
30 x 30	48	1	26S	644	755	1,010	891	109	48	242
36 x 36	62	1	32S-3	735	852	1,141	986	109	48	347
42 x 42	78	1	32S-3	859	1,027	1,374	1,158	109	48	473
48 x 48	125	1	38Q	1,078	1,259	1,659	1,391	163	N/A	617
54 x 54	145	1	38Q	1,302	1,636	2,005	1,770	163	N/A	781
60 x 60	168	1	38Q	1,364	1,676	2,163	1,811	163	N/A	965

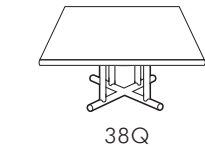

- ST3X- Pedestal Base
- T one column end base
- TT two column end base

**ST3X
RECTANGULAR
PEDESTAL BASE**



Wood Edges Only

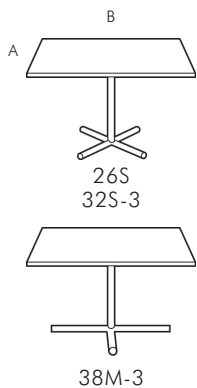

Table Size A x B x C	Apprx WT	Bases	Base Size	1300 / 1333 1340 / 1440	1444 / 2323	2405 / 2420	2344	Polished Chrome Upcharge	Welded Base Upcharge	Veneer Upcharge
24 x 30	43	1	26S	614	721	954	853	109	48	194
24 x 36	47	1	26S	644	750	1,010	882	109	48	231
30 x 36	55	1	32S-3	692	814	1,088	948	109	48	290
30 x 48	68	1	38M-3	777	908	1,216	1,043	163	48	385
36 x 48	77	1	38M-3	836	995	1,308	1,130	163	48	463

- ST3X- Pedestal Base
- T one column end base
- TT two column end base

NOTES

- Standard Grade 1 Laminate and any Grade 3 Powdercoat.
- Wood edges standard in Maple. Other species available, call for pricing.
- All prices are list delivered to Zone 1. Add 4% for Zone 2.
- Standard table height: 28 3/4"
- Storm wheel not available with X Base

Veneer is Maple Long Grain, Oak available at same price, Order Must Specify

STATIONARY

- Grade 3 powdercoat, Grade 1 laminate, standard wood finish
- Several optional power solutions available



Wood Edges Only

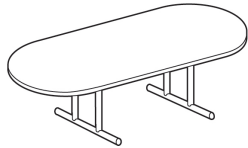

ST3T RACETRACK

Table Size A x B	Apprx WT	Bases	Base Size	1300 / 1333 1340 / 1440	1444 / 2323	2405 / 2420	2344	Polished Chrome Upcharge	Welded Base Upcharge	Veneer Upcharge
36 x 72	112	2	24T	1,016	1,217	1,842	1,352	109	48	694
42 x 84	163	2	32TT	1,763	1,849	2,643	1,983	163	48	945
42 x 96	180	2	32TT	1,777	1,897	2,827	2,033	163	48	1,080
48 x 96	199	2	38TT	1,829	1,963	2,874	2,095	163	48	1,235
48 x 120	262	3	38TT	2,268	2,459	3,469	2,597	216	48	1,544
48 x 144	299	3	38TT	2,453	2,695	3,797	2,826	216	48	1,851
60 x 120	309	3	38TT	2,468	2,695	3,730	2,826	216	48	1,929
60 x 144	356	3	38TT	2,682	2,964	4,092	3,100	216	48	2,314

- * Tables 144" or longer ship in two pieces
- ST3T- Symmetrical end base



Wood Edges Only

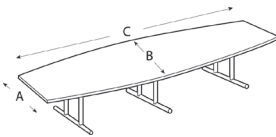

ST3T BOATSHAPE

Table Size A x B x C	Apprx WT	Bases	Base Size	1300 / 1333 1340 / 1440	1444 / 2323	2405 / 2420	2344	Polished Chrome Upcharge	Welded Base Upcharge	Veneer Upcharge
30 x 42 x 96	181	2	32TT	1,777	1,897	2,827	2,033	163	48	1,080
36 x 48 x 120	262	3	38TT	2,268	2,229	3,469	2,360	216	48	1,544
36 x 48 x 144	299	3	38TT	2,453	2,422	3,797	2,555	216	48	1,851
42 x 60 x 192	450	3	38TT	4,660	4,387	6,945	4,519	216	48	3,086

- * Tables 144" or longer ship in two pieces
- ST3T- Symmetrical end base

NOTES

- Standard Grade 1 Laminate and any Grade 3 Powdercoat.
- Wood edges standard in Maple. Other species available, call for pricing.
- All prices are list delivered to Zone 1. Add 4% for Zone 2.
- Standard table height: 28 3/4"

Veneer is Maple Long Grain, Oak available at same price, Order Must Specify

STATIONARY

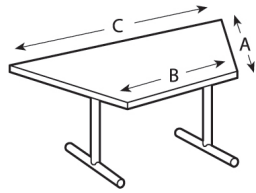

ST3T
TRAPEZOID



Table Size A x B x C	Apprx WT	Base Style	1333/ 1440	2323	2420	Polished Chrome Upcharge	Welded Base Upcharge	Veener Upcharge
24 x 24 x 48	74	14T	884	1,068	1,374	109	48	309
30 x 30 x 60	90	18T	1,062	1,281	1,755	109	48	482
36 x 36 x 72	106	24T	1,204	1,423	2,105	109	48	694

- **ST3T**- Symmetrical end base
- First two numbers of base style is base dimension
- Veneer available only on: 2323, 2420

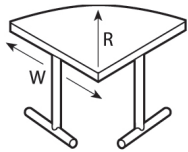

ST3T
QUARTER ROUND



Table Size W x R	Apprx WT	Base Style	1333/ 1440	2323	2420	Polished Chrome Upcharge	Welded Base Upcharge	Veener Upcharge
30 x 30	67	18T	882	1,048	1,287	109	48	242
36 x 36	77	24T	918	1,090	1,432	109	48	347

- **ST3T**- Symmetrical end base
- First two numbers of base style is base dimension
- Veneer available only on: 2323, 2420

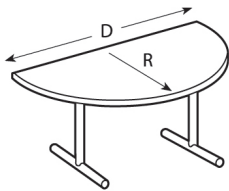

ST3T
HALF ROUND



Table Size R x D	Apprx WT	Base Style	1333/ 1440	2323	2420	Polished Chrome Upcharge	Welded Base Upcharge	Veener Upcharge
24 x 48	90	14T	864	1,048	1,353	109	48	309
30 x 60	108	18T	1,042	1,261	1,732	109	48	482
36 x 72	126	24T	1,185	1,404	2,086	109	48	694

- **ST3T**- Symmetrical end base
- First two numbers of base style is base dimension
- Veneer available only on: 2323, 2420

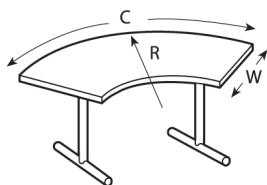

ST3T
CRESCENT



Table Size W x R x C	Apprx WT	Base Style	1333/ 1440	2323	2420	Polished Chrome Upcharge	Welded Base Upcharge	Veener Upcharge
24 x 48 x 75.5	69	18T	1,174	1,394	1,847	109	48	965
30 x 60 x 94	123	24T	1,747	1,889	2,650	109	48	733
36 x 72 x 113	152	24T	1,833	2,011	3,147	109	48	2,180

- **ST3T**- Symmetrical end base
- First two numbers of base style is base dimension
- Veneer available only on: 2323, 2420

NOTES

- Standard Grade 1 Laminate and any Grade 3 Powdercoat.
- Wood edges standard in Maple. Other species available, call for pricing.
- All prices are list delivered to Zone 1. Add 4% for Zone 2.
- Standard table height: 28 3/4"
- Shipped knocked down



STORM WHEEL OPTION

For added mobility specify the Storm Wheel and add \$135 per table. The Storm Wheel replaces one pair of end caps in an end base table up to 96" in length and facilitates easy movement for reconfiguring tables – merely pick up one end of the table and move.

FLIP TOP/NESTING - SINGLE HANDLE OPERATION

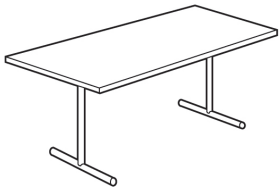

ST6TN OR ST6CN RECTANGLE



- **ST6TN** - Symmetrical end base - Flip Top/Nesting
- **ST6CN** - Cantilever End Base - Flip Top/Nesting
- Single center handle mechanism
- Stabilizing bar between legs
- First two numbers of base style is base dimension

Table Size A x B	Apprx WT	Base Style	1300/ 1333/ 1340/ 1440	1444/ 2323	2405/ 2420	2344	4720	4150	Polished Chrome Upcharge
24 x 42	85	18T or C	791	920	1,184	1,037	904	1,202	109
24 x 48	90	18T or C	905	1,053	1,353	1,186	1,033	1,374	109
24 x 60	97	18T or C	959	1,141	1,486	1,271	1,145	1,463	109
24 x 72	107	18T or C	1,035	1,214	1,597	1,346	1,260	1,615	109
30 x 42	104	24T	834	952	1,222	1,069	975	1,363	109
30 x 48	109	24T	954	1,089	1,397	1,223	1,113	1,558	109
30 x 60	122	24T	1,043	1,216	1,581	1,351	1,251	1,680	109
30 x 72	138	24T	1,097	1,282	1,697	1,413	1,339	1,889	109
36 x 48	122	24T	1,015	1,174	1,490	1,308	1,196	1,640	109
36 x 60	138	24T	1,084	1,269	1,723	1,403	1,330	1,889	109
36 x 72	154	24T	1,151	1,316	1,836	1,451	1,444	2,073	109

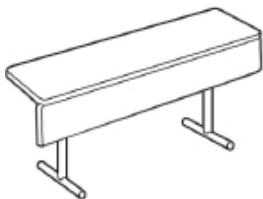

ST6TNM OR ST6CNM MODESTY PANEL



- **ST6TNM** - Symmetrical End Base - Flip Top/Nesting
- **ST6CNM** - Cantilever End Base - Flip Top/Nesting
- Single center handle mechanism
- Stabilizing bar between legs

Table Size A x B	Apprx WT	Base Style	1300/ 1333/ 1340/ 1440	1444/ 2323	2405/ 2420	2344	4720	4150	Polished Chrome Upcharge
24 x 42	97	18T or C	1,063	1,192	1,454	1,309	1,175	1,473	109
24 x 48	102	18T or C	1,177	1,324	1,625	1,458	1,308	1,676	109
24 x 60	110	18T or C	1,260	1,443	1,788	1,574	1,446	1,767	109
24 x 72	129	18T or C	1,365	1,545	1,931	1,677	1,592	1,919	109
30 x 42	110	24T	1,106	1,224	1,493	1,341	1,245	1,634	109
30 x 48	115	24T	1,226	1,361	1,667	1,495	1,387	1,858	109
30 x 60	134	24T	1,343	1,517	1,883	1,654	1,550	1,983	109
30 x 72	148	24T	1,428	1,615	2,027	1,748	1,857	2,190	109

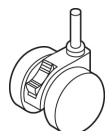

451056 - DUAL WHEEL LOCKING CASTERS \$135 (SET OF 4)

- 2-1/2" Diameter
- If ordered with table will not increase table height.
- If retrofitted will increase table height 2".
- Color: Black plastic.
- Available on: ST6TN, ST6CN, ST6TNM, ST6CNM, ST6X and ST6TB Stationary, Butterfly Flip and Folding Tables.



STORM WHEEL OPTION

For added mobility specify the Storm Wheel and add \$135 per table. The Storm Wheel replaces one pair of end caps in an end base table up to 96" in length and facilitates easy movement for reconfiguring tables – merely pick up one end of the table and move.

FLIP TOP



**ST6X
SQUARE**



Table Size A x B	Apprx WT	Base Style	1300/ 1333/ 1340/ 1440	1444/ 2323	2405/ 2420	2344	Polished Chrome Upcharge
30 x 30	63	26S	755	868	1,120	1,000	109
36 x 36	85	32S-3	847	966	1,255	1,099	109

- **ST6X**- Pedestal Base / Flip Top
- First two numbers of base style is base dimension



**ST6X
RECTANGLE**



Table Size A x B	Apprx WT	Base Style	1300/ 1333/ 1340/ 1440	1444/ 2323	2405/ 2420	2344	Polished Chrome Upcharge
24 x 30	60	26S	726	836	1,068	968	109
24 x 36	72	26S	755	863	1,120	995	109
30 x 36	79	32S-3	806	927	1,200	1,059	109

- **ST6X**- Pedestal Base / Flip Top
- First two numbers of base style is base dimension



**ST6X
ROUND**



Diameter	Apprx WT	Base Style	1300/ 1333/ 1340/ 1440	1444/ 2323	2405/ 2420	2344	4150	Polished Chrome Upcharge
30	63	26S	783	928	1,449	1,060	N/A	109
36	78	32S-3	828	1,000	1,543	1,135	N/A	109
42	98	32S-3	1,013	1,235	1,766	1,366	N/A	109
48	135	32S-3	1,035	1,271	1,829	1,406	2,224	109

- **ST6X**- Pedestal Base / Flip Top
- First two numbers of base style is base dimension

NOTES

- Standard Grade 1 Laminate and any Grade 3 Powdercoat.
- Wood edges standard in Maple. Other species available, call for pricing.
- All prices are list delivered to Zone 1. Add 4% for Zone 2.
- Standard table height: 28 3/4"
- Shipped knocked down
- Storm wheel not available with X Base

FLIP TOP/NESTING - DOUBLE HANDLE OPERATION

ST6T
RECTANGLE

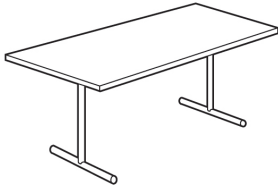

Table Size A x B	Apprx WT	Base Style	1300/ 1333/ 1340/ 1440	1444/ 2323	2405/ 2420	2344	4720	4150	Polished Chrome Upcharge
24 x 48	90	18T	905	1,053	1,353	1,186	1,033	1,374	109
24 x 60	97	18T	959	1,141	1,486	1,271	1,145	1,463	109
24 x 72	107	18T	1,035	1,214	1,597	1,346	1,260	1,615	109
30 x 48	109	24T	954	1,089	1,397	1,223	1,113	1,558	109
30 x 60	122	24T	1,043	1,216	1,581	1,351	1,251	1,680	109
30 x 72	138	24T	1,097	1,282	1,697	1,413	1,339	1,889	109
36 x 48	122	24T	1,015	1,174	1,490	1,308	1,196	1,640	109
36 x 60	138	24T	1,084	1,269	1,723	1,403	1,330	1,889	109
36 x 72	154	24T	1,151	1,316	1,836	1,451	1,444	2,073	109

- **ST6T**- Symmetrical end base / Flip Top
- First two numbers of base style is base dimension

ST6TC
CLAMP ON
MODESTY PANEL

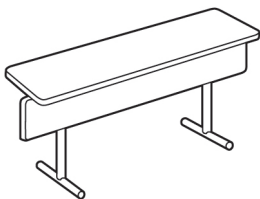

Table Size A x B	Apprx WT	Base Style	1300/ 1333/ 1340/ 1440	1444/ 2323	2405/ 2420	2344	4720	4150	Polished Chrome Upcharge
24 x 48	102	18T	1,177	1,324	1,625	1,458	1,308	1,676	109
24 x 60	110	18T	1,260	1,443	1,788	1,574	1,446	1,767	109
24 x 72	129	18T	1,365	1,545	1,931	1,677	1,592	1,919	109
30 x 48	115	24T	1,226	1,361	1,667	1,495	1,387	1,858	109
30 x 60	134	24T	1,343	1,517	1,883	1,654	1,550	1,983	109
30 x 72	148	24T	1,428	1,615	2,027	1,748	1,857	2,190	109

- **ST6TC**- Symmetrical end base / Flip Top
- First two numbers of base style is base dimension



STORM WHEEL OPTION

For added mobility specify the Storm Wheel and add \$135 per table. The Storm Wheel replaces one pair of end caps in an end base table up to 96" in length and facilitates easy movement for reconfiguring tables – merely pick up one end of the table and move.

FLIP TOP/NESTING - DOUBLE HANDLE OPERATION

**ST6T
TRAPEZOID**

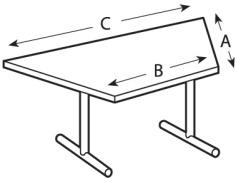

Table Size A x B x C	Apprx WT	Base Style	1333/ 1440	2323	2420	Polished Chrome Upcharge
24 x 24 x 48	78	14T	1,110	1,266	1,598	109
30 x 30 x 60	94	18T	1,289	1,482	1,981	109
36 x 35 x 72	110	24T	1,432	1,627	2,332	109

- **ST6T**- Symmetrical end base / Flip Top
- First two numbers of base style is base dimension

**ST6T
HALF ROUND**

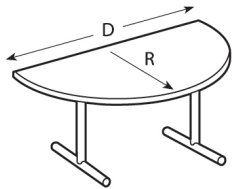

Table Size R x D	Apprx WT	Base Style	1333/ 1440	2323	2420	Polished Chrome Upcharge
24 x 48	94	14T	1,090	1,266	1,577	109
30 x 60	112	18T	1,269	1,482	1,964	109
36 x 72	130	24T	1,410	1,627	2,313	109

- **ST6T**- Symmetrical end base / Flip Top
- First two numbers of base style is base dimension

**ST6T
CRESCENT**

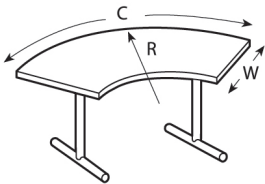

Table Size W x R x C	Apprx WT	Base Style	1333/ 1440	2323	2420	Polished Chrome Upcharge
24 x 48 x 75.5	73	18T	1,404	1,504	2,076	109
30 x 60 x 94	127	24T	1,974	1,994	2,875	109
36 x 72 x 113	156	24T	2,058	2,115	3,375	109

- **ST6T**- Symmetrical end base / Flip Top
- First two numbers of base style is base dimension

NOTES

- Standard Grade 1 Laminate and any Grade 3 Powdercoat.
- Wood edges standard in Maple. Other species available, call for pricing.
- All prices are list delivered to Zone 1. Add 4% for Zone 2.
- Standard table height: 28 3/4"
- Shipped knocked down

BUTTERFLY FLIP TOP

ST6TB RECTANGLE

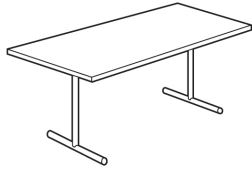

Table Size A x B	Apprx WT	Base Style	1300/ 1333/ 1340/ 1440	1444/ 2323	2405/ 2420	2344	4720	Polished Chrome Upcharge
30 x 48	109	24T	1,225	1,375	1,681	1,508	1,339	109
30 x 60	122	24T	1,314	1,479	1,871	1,635	1,475	109
30 x 72	138	24T	1,382	1,503	1,981	1,706	1,566	109

- **ST6TB**- Symmetrical end base / Butterfly Flip Top
- First two numbers of base style is base dimension

ST6TB TRAPEZOID

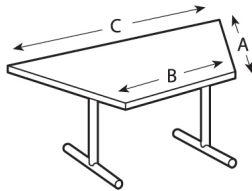
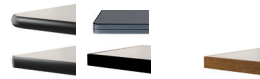

Table Size A x B x C	Apprx WT	Base Style	1300/ 1333/ 1340/ 1440	2323	Polished Chrome Upcharge
30 x 30 x 60	94	18T	1,574	1,793	109

- **ST6TB**- Symmetrical end base / Butterfly Flip Top
- First two numbers of base style is base dimension

ST6TB HALF ROUND

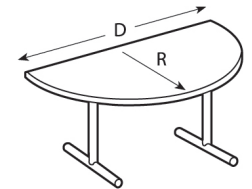

Table Size A x B x C	Apprx WT	Base Style	1300/ 1333/ 1340/ 1440	2323	Polished Chrome Upcharge
30 x 60	112	18T	1,554	1,772	109

- **ST6TB**- Symmetrical end base / Butterfly Flip Top
- First two numbers of base style is base dimension

NOTES

- Standard Grade 1 Laminate and any Grade 3 Powdercoat.
- Wood edges standard in Maple. Other species available, call for pricing.
- All prices are list delivered to Zone 1. Add 4% for Zone 2.
- Standard table height: 28 3/4"
- Shipped assembled.
- Top is removable



STORM WHEEL OPTION

For added mobility specify the Storm Wheel and add \$135 per table. The Storm Wheel replaces one pair of end caps in an end base table up to 96" in length and facilitates easy movement for reconfiguring tables – merely pick up one end of the table and move.

FOLDING

ST5T SQUARE

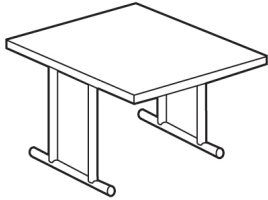

Table Size A x B	Apprx WT	Base Style	1300/ 1333/ 1340/ 1440	1444/ 2323	2405/ 2420	2344	Polished Chrome Upcharge
60 x 60*	249	38TT	1,665	1,676	2,163	2,114	163

- *Overfold base
- **ST5T**- Symmetrical end base
- First two numbers of base style is base dimension
- "TT" in base number represents two column end base

ST5T RECTANGLE

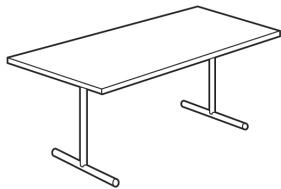

Table Size A x B	Apprx WT	Base Style	1300/ 1333/ 1340/ 1440	1444/ 2323	2405/ 2420	2344	4150	Polished Chrome Upcharge
18 x 48*	74	14T	969	1,044	1,330	1,174	1,508	109
18 x 60	81	14T	989	1,130	1,438	1,263	1,575	109
18 x 72	88	14T	1,031	1,174	1,523	1,308	1,731	109
18 x 90	103	14T	1,342	1,549	2,143	1,681	N/A	109
24 x 48*	86	18T	982	1,129	1,428	1,263	1,575	109
24 x 60	96	18T	1,036	1,216	1,561	1,348	1,604	109
24 x 72	105	18T	1,106	1,288	1,673	1,422	1,766	109
24 x 90	127	18T	1,436	1,663	2,223	1,795	N/A	109
30 x 48*	106	24T	1,033	1,162	1,472	1,298	1,766	109
30 x 60	110	24T	1,115	1,290	1,659	1,424	1,837	109
30 x 72	122	24T	1,170	1,357	1,770	1,493	2,059	109
30 x 90	170	24T	1,596	1,719	2,299	1,848	N/A	109
36 x 48*	115	24T	1,091	1,254	1,563	1,386	1,903	109
36 x 60	122	24T	1,157	1,344	1,798	1,476	2,059	109
36 x 72	136	24T	1,224	1,392	1,913	1,524	2,261	109
36 x 90	188	24T	1,665	1,896	2,412	2,032	N/A	109

- * Overfold base
- **ST5T**- Symmetrical end base
- First two numbers of base style is base dimension

NOTES

- Standard Grade 1 Laminate and any Grade 3 Powdercoat,
- Folding Tables not available with Veneer.
- Wood edges standard in Maple. Other species available, call for pricing.
- All prices are list delivered to Zone 1. Add 4% for Zone 2.
- Standard table height: 28 3/4"



STORM WHEEL OPTION

For added mobility specify the Storm Wheel and add \$135 per table. The Storm Wheel replaces one pair of end caps in an end base table up to 96" in length and facilitates easy movement for reconfiguring tables – merely pick up one end of the table and move.

LIGHT WEIGHT FOLDING

ST5T LIGHT WEIGHT RECTANGLE

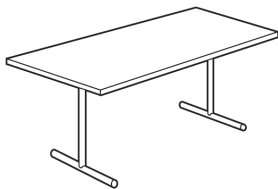

Table Size A x B	Apprx WT	Base Style	1307/ 1337/ 1347/ 1447	1448/ 2327	2407/ 2427	2348	4157	Polished Chrome Upcharge
18 x 60	65	14T	1,038	1,174	1,482	1,310	1,575	109
18 x 72	70	14T	1,087	1,235	1,577	1,366	1,731	109
18 x 90	81	14T	1,410	1,622	2,213	1,756	N/A	109
24 x 60	76	18T	1,098	1,275	1,625	1,409	1,604	109
24 x 72	82	18T	1,184	1,364	1,754	1,498	1,766	109
24 x 90	99	18T	1,529	1,758	2,315	1,889	N/A	109
30 x 60	86	24T	1,198	1,369	1,738	1,504	1,837	109
30 x 72	94	24T	1,266	1,453	1,869	1,587	2,059	109
30 x 90	134	24T	1,716	1,836	2,417	1,969	N/A	109
36 x 60	94	24T	1,255	1,440	1,891	1,573	2,059	109
36 x 72	103	24T	1,338	1,505	2,023	1,638	2,261	109
36 x 90	145	24T	1,807	2,044	2,554	2,172	N/A	109

- **ST5T**- Symmetrical end base
- First two numbers of base style is base dimension



STORM WHEEL OPTION

For added mobility specify the Storm Wheel and add \$135 per table. The Storm Wheel replaces one pair of end caps in an end base table up to 96" in length and facilitates easy movement for reconfiguring tables – merely pick up one end of the table and move.

LIGHT WEIGHT FOLDING

ST5TA LIGHT WEIGHT FOLDING MODESTY PANEL

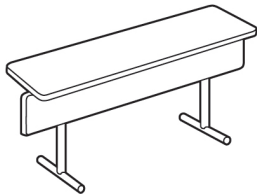

Table Size A x B	Apprx WT	Base Style	1307/ 1337/ 1347/ 1447	1448/ 2327	2407/ 2427	2348	4157	Polished Chrome Upcharge
24 x 60	83	18T	1,400	1,577	1,927	1,713	2,057	109
24 x 72	91	18T	1,516	1,697	2,083	1,831	2,219	109
24 x 90	102	18T	1,890	2,119	2,675	2,253	N/A	109
30 x 60	97	24T	1,501	1,670	2,038	1,806	2,290	109
30 x 72	110	24T	1,596	1,782	2,200	1,919	2,513	109
30 x 90	103	24T	2,078	2,200	2,776	2,332	N/A	109

- **ST5TA**- Symmetrical end base
- First two numbers of base style is base dimension
- Butterfly Flip Top Tables w/ removable top

ST5CR LIGHT WEIGHT REMOVABLE MODESTY PANEL

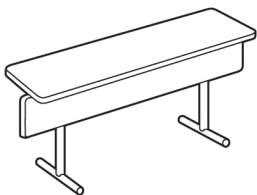

Table Size A x B	Apprx WT	Base Style	1307/ 1337/ 1347/ 1447	1448/ 2327	2407/ 2427	2348	4157	Polished Chrome Upcharge
18 x 48*	74	14C	1,339	1,476	1,784	1,614	1,800	109
18 x 60	81	14C	1,419	1,565	1,913	1,700	1,905	109
18 x 72	95	14C	1,773	1,981	2,574	2,118	2,068	109

- *Overfold base
- **ST5CR**- Cantilever end base
- First two numbers of base style is base dimension

NOTES

- Standard Grade 1 Laminate and any Grade 3 Powdercoat,
- Folding Tables not available with Veneer.
- Wood edges standard in Maple. Other species available, call for pricing.
- All prices are list delivered to Zone 1. Add 4% for Zone 2.
- Standard table height: 28 3/4"
- Shipped assembled.



STORM WHEEL OPTION

For added mobility specify the Storm Wheel and add \$135 per table. The Storm Wheel replaces one pair of end caps in an end base table up to 96" in length and facilitates easy movement for reconfiguring tables – merely pick up one end of the table and move.

FOLDING

ST5CR REMOVABLE MODESTY PANEL

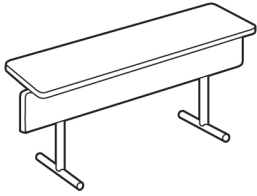

Table Size A x B	Apprx WT	Base Style	1300/ 1333/ 1340/ 1440	1444/ 2323	2405/ 2420	2344	4150	Polished Chrome Upcharge
18 x 48*	82	14C	1,240	1,315	1,600	1,449	1,812	106
18 x 60	91	14C	1,290	1,432	1,739	1,563	1,879	106
18 x 72	100	14C	1,362	1,507	1,852	1,640	2,037	106
18 x 90	118	14C	1,706	1,913	2,504	2,048	N/A	106

- *Overfold base
 • **ST5CR**- Cantilever end base
 • First two numbers of base style is base dimension

ST5TA FOLDING MODESTY PANEL

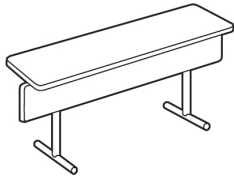

Table Size A x B	Apprx WT	Base Style	1300/ 1333/ 1340/ 1440	1444/ 2323	2405/ 2420	2344	4150	Polished Chrome Upcharge
24 x 48*	106	18T	1,255	1,400	1,702	1,534	2,030	109
24 x 60	115	18T	1,337	1,517	1,866	1,653	2,057	109
24 x 72	130	18T	1,441	1,622	2,008	1,756	2,219	109
24 x 90	150	18T	1,797	2,023	2,584	2,157	N/A	109
30 x 48*	126	24T	1,301	1,438	1,745	1,570	2,219	109
30 x 60	70	24T	1,420	1,592	1,959	1,726	2,290	109
30 x 72	153	24T	1,504	1,688	2,103	1,827	2,513	109
30 x 90	175	24T	1,959	2,080	2,661	2,213	N/A	109

- *Overfold base
 • **ST5TA**- Symmetrical end base
 • First two numbers of base style is base dimension

ST5T ROUND

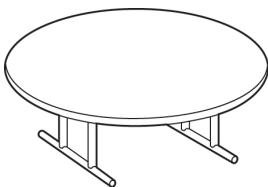

Table Size D	Apprx WT	Base Style	1300/ 1333/ 1340/ 1440	1444/ 2323	2405/ 2420	2344	4150	Polished Chrome Upcharge
60*	194	32TT	1,830	2,168	3,041	2,301	3,466	163

- *Overfold base
 • **ST5T**- Symmetrical end base
 • First two numbers of base style is base dimension
 • "TT" in base number represents two column end base



STORM WHEEL OPTION

For added mobility specify the Storm Wheel and add \$135 per table. The Storm Wheel replaces one pair of end caps in an end base table up to 96" in length and facilitates easy movement for reconfiguring tables – merely pick up one end of the table and move.

FOLDING

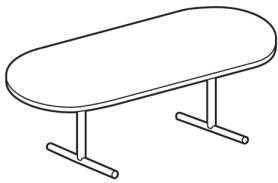

**ST5T
RACETRACK**



Table Size A x B	Apprx WT	Base Style	1300/ 1333/ 1340/ 1440	1444/ 2323	2405/ 2420	2344	Polished Chrome Upcharge
36 x 72	166	24T	1,507	1,708	2,332	1,842	109

- **ST5T**- Symmetrical end base
- First two numbers of base style is base dimension

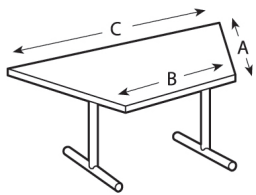

**ST5T
TRAPEZOID**



Table Size A x B x C	Apprx WT	Base Style	1333/ 1440	2323	2420	Polished Chrome Upcharge
36 x 36 x 72*	117	24T	1,507	1,759	2,409	109

- *Overfold base
- **ST5T**- Symmetrical end base
- First two numbers of base style is base dimension

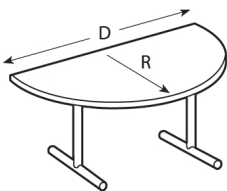

**ST5T
HALF ROUND**



Table Size R x D	Apprx WT	Base Style	1333/ 1440	2323	2420	Polished Chrome Upcharge
24 x 48*	97	14T	1,166	1,438	1,656	109
30 x 60*	116	18T	1,343	1,616	2,038	109
36 x 72*	134	24T	1,490	1,750	2,389	109

- *Overfold base
- **ST5T**- Symmetrical end base
- First two numbers of base style is base dimension

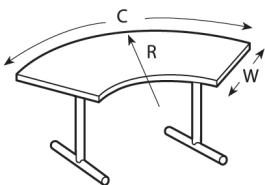

**ST5T
CRESCENT**



Table Size W x R x C	Apprx WT	Base Style	1333/ 1440	2323	2420	Polished Chrome Upcharge
30 x 60 x 94*	143	24T	2,050	2,243	2,951	109
36 x 72 x 113	165	24T	2,136	2,365	3,452	109

- *Overfold base
- **ST5T**- Symmetrical end base
- First two numbers of base style is base dimension

NOTES

- Standard Grade 1 Laminate and any Grade 3 Powdercoat,
- Folding Tables not available with Veneer.
- Wood edges standard in Maple. Other species available, call for pricing.
- All prices are list delivered to Zone 1. Add 4% for Zone 2.
- Standard table height: 28 3/4"
- Shipped assembled.

BRIDGES

STB BRIDGES

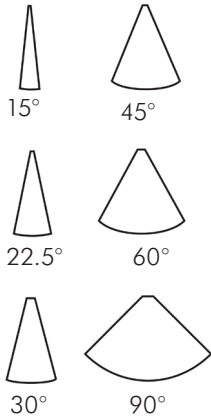

Degree Angle	Apprx WT	Width	1440	2323	Veener Upcharge
15°	5	24	375	439	270
22.5°	7	24	375	439	275
30°	10	24	428	567	275
45°	15	24	400	534	305
60°	20	24	428	573	328
90°	30	24	375	498	478
15°	8	30	451	608	240
22.5°	12	30	428	567	311
30°	15	30	428	567	334
45°	23	30	451	608	363
60°	31	30	485	660	388
90°	46	30	428	573	546
15°	11	36	468	660	318
22.5°	17	36	468	660	347
30°	22	36	468	660	377
45°	33	36	604	809	485
60°	44	36	672	932	540

STSB SQUARE BRIDGE

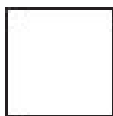

Table Size A x B	Apprx WT	1440	2323	Veener Upcharge
24 x 24	19	299	382	155
30 x 30	29	336	434	242
36 x 36	42	375	490	347

NOTES

- Standard Grade 1 Laminate and any Grade 3 Powdercoat.
- Wood edges standard in Maple. Other species available, call for pricing.
- All prices are list delivered to Zone 1. Add 4% for Zone 2.
- Standard table height: 28 3/4"
- For use with all Stationary, Flip, and Folding Tables
- Must be Ganged
- Veneer available only on 2323



STORM WHEEL OPTION

For added mobility specify the Storm Wheel and add \$135 per table. The Storm Wheel replaces one pair of end caps in an end base table up to 96" in length and facilitates easy movement for reconfiguring tables – merely pick up one end of the table and move.

ADJUSTABLE HEIGHT

ST7X
ROUND

Table Size D	Apprx WT	Column Type	1333/ 1440	2323	Veener Upcharge
30	59	ROUND	1,406	1,560	242
36	77	ROUND	1,456	1,633	347
42	127	ROUND	1,615	1,842	473
48	151	ROUND	1,633	1,883	617

Tables adjust from a sitting height of 26" to a standing height of 39".

- **ST7X**- Pedestal Base
- Veneer available only on 2323

ST7X
SQUARE

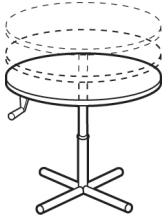
Table Size A x B	Apprx WT	Column Type	1333/ 1440	2323	Upcharge Veneer
30 x 30	60	ROUND	1,377	1,497	242
36 x 36	90	ROUND	1,426	1,565	347
42 x 42	128	ROUND	1,573	1,746	473

Tables adjust from a sitting height of 26" to a standing height of 39".

- **ST7X**- Pedestal Base
- Veneer available only on 2323

NOTES

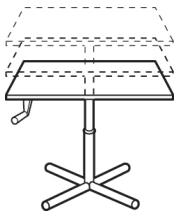
- Standard Grade 1 Laminate and any Grade 3 Powdercoat.
- Wood edges standard in Maple. Other species available, call for pricing.
- Storm wheel not available on X bases
- All prices are list delivered to Zone 1. Add 4% for Zone 2.
- Standard table height: 28 3/4"
- Shipped assembled.

ADJUSTABLE HEIGHT

ST7T
RECTANGLE

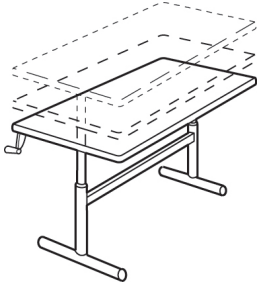

Table Size A x B	Apprx WT	Column Type	1333/ 1440	2323	4720	Veener Upcharge
18 x 48	78	ROUND	2,314	2,498	2,498	231
18 x 60	87	ROUND	2,397	2,555	2,555	290
18 x 72	95	ROUND	2,450	2,615	2,615	347
18 x 90	107	ROUND	2,725	2,884	2,884	434
24 x 48	90	ROUND	2,354	2,551	2,551	309
24 x 60	101	ROUND	2,451	2,610	2,610	385
24 x 72	112	ROUND	2,500	2,670	2,670	463
24 x 90	129	ROUND	2,784	2,944	2,944	579
30 x 48	114	ROUND	2,423	2,624	2,624	385
30 x 60	113	ROUND	2,518	2,701	2,701	482
30 x 72	126	ROUND	2,573	2,769	2,769	579
30 x 90	156	ROUND	2,865	3,008	3,008	724
36 x 48	114	ROUND	2,493	2,675	2,675	463
36 x 60	128	ROUND	2,547	2,760	2,760	579
36 x 72	142	ROUND	2,628	2,829	2,829	694
36 x 90	168	ROUND	2,933	3,201	3,201	868

Tables adjust from a sitting height of 26" to a standing height of 39".
 If using 4720, the Post Formed edge will be on the handle side of the top.
 • **ST7T**- Symmetrical end base
 • Veneer available only on 2323

ST7TS
SPLIT TOP

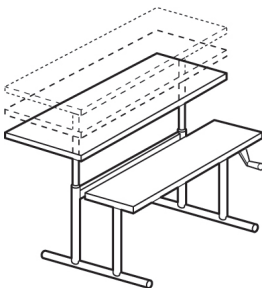

Table Size R x D	Apprx WT	Column Type	1333/ 1440	2323	4720	Veener Upcharge
36 x 48	137	ROUND	4,400	4,707	4,666	463
36 x 60	154	ROUND	4,484	4,815	4,791	579
36 x 72	170	ROUND	4,568	4,941	4,874	694

Two separately adjustable work surfaces enable greater technology management flexibility.
 Both surfaces adjust from a minimum of 24" to a maximum of 36".
 If using 4720, the Post Formed edge will be on the handle side of the top.
 • **ST7T S**- Symmetrical end base
 • Veneer available only on 2323



STORM WHEEL OPTION

For added mobility specify the Storm Wheel and add \$135 per table. The Storm Wheel replaces one pair of end caps in an end base table up to 96" in length and facilitates easy movement for reconfiguring tables – merely pick up one end of the table and move.

SPECIFICATIONS

HOW TO ORDER

When ordering please specify:

1. Model Number & Edge Selection Number
2. Quantity
3. Shape
4. Size
5. Base Finish
6. Top Selection (laminite pattern number and description, veneer finish number and description)
7. Edge Finish Selection (specify wood finish and species if ordering wood edges)
8. Options
9. Small Order Charge
Orders with a combined Net price under \$1,000 will be subject to a Special Handling Charge of \$125 Net. One charge per order.

EDGE AND MODESTY PROFILES



4720 Postformed
1-1/4" plastic laminate top. The front edge is sloped, reducing strain on the wrist. The side and rear edge are banded with rigid PVC molding.
Modesty edge 1440



1300 / 1307 Bumper T-Mold
1-1/4" laminate top. The edges are banded with solid vinyl "T" molding, with 7/8" radius at corners.
Modesty edge 1300



1333 / 1337 Eased T-Mold
1-1/4" laminate top. The edges are banded with solid vinyl "T" molding, with 1" radius at corners.
Modesty edge 1300



4150 / 4157 Sloped Urethane
1-1/4" laminate top. The front urethane edge is sloped, reducing strain on the wrist. The sides and rear have a flat urethane edge.
Modesty edge 1440



1340 / 1347 Reveal T-Mold
1-1/4" laminate top. The edges are banded with 5/16" solid vinyl "T" molding, with 7/8" radius at corners.
Modesty edge 1300

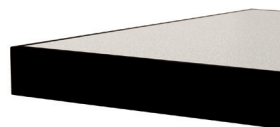

1440 / 1447 Flat PVC
1-1/4" laminate top. The edges are banded with flat PVC molding. No radius at corners.
Modesty edge 1440

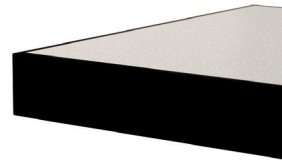

1444 / 1448 Flat PVC
1-3/4" laminate top. The edges are banded with flat PVC molding. No radius at corners.
Modesty edge 1440



2405 / 2407 Wood Bullnose
1-1/4" laminate top. The edges are banded with hardwood. No radius at corners.
Modesty edge Flat Wood Band



2323 / 2327 Wood Band
1-1/4" laminate top. The edges are banded with 1/4" hardwood. No radius at corners.
Modesty edge Flat Wood Band



2344 / 2348 Wood Band
1-3/4" laminate top. The edges are banded with 1/4" hardwood. No radius at corners.
Modesty edge Flat Wood Band



2420 / 2427 Wood Edge
1-1/4" laminate top. The edges are banded with hardwood. No radius at corners.
Modesty edge Flat Wood Band

STANDARD TABLE HEIGHT: 28 3/4"

TOP CONSTRUCTION

Substrate

High density 45 lb. core with backing sheet

Laminite

.050 thick high pressure plastic manufactured to N.E.M.A. standards, .045 thick phenolic resin sheet on underside.

Veneer

1/32" thick genuine hardwood top which is stained and sealed on the bottom. Veneer not available with light weight core. Specify: oak, walnut, mahogany, maple, cherry. Edge species are the same as that of top veneer. See color chart for finishes. Not recommended on Folding Tables.

Light Weight Top

Most light weight tops produced using light weight composite wood construction, specially designed to provide light weight rigidity. The core is 7/8" thick. Edges are built up to 1-1/4" using 1/4" fiberboard on perimeter of frame. Tops are balanced construction with plastic laminite or veneer surfaces and phenolic backer.

UNDERSTRUCTURE SPECIFICATIONS

GLIDES

Adjustable glides are standard on all tables.

- 1-3/8" diameter black nylon with steel support housing
- 5/16-18 x 1" threaded stem

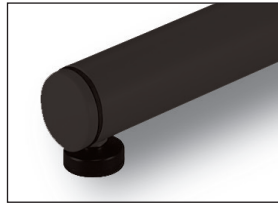

Legs

- **ST3T Stationary**
- **ST5T Folding**
- **ST6T Flip Top**
- **ST8T C-Leg**
- Inverted "T"-shape or double "T" (TT) depending on top width.
- Made from 1-3/4" diameter 14 gauge steel tubing.



Pedestal Base

- **ST3X Stationary**
- **ST5X Folding**
- **ST6X Flip Top**
- Foot - "X" shaped made with 1-3/4" diameter 14 gauge steel tubing.
- Column - one 2-1/4" diameter 14 gauge, or one 3" diameter 16 gauge, or four 1-3/4" diameter 14 gauge steel tubing depending on top size.
- Single column bases bolt together with a single 1/2"-13" x 26-1/4" long bolt. The bolt threads up through X-foot, column and into threaded insert in mounting plate.
- Four-column bases bolted together using eight 1/2"-13 bolts threaded into steel inserts welded into columns.
- Mounting plates are 10" x 10"-7 gauge cold formed steel for single column bases.
- 14" x 14"- 7 gauge for four-column bases.

END CAPS

- Die cast aluminum pressed in place.
- Black reveal rings are sandwiched between end cap and tube end.



Stationary Base

- **ST3 Series**
- 10" square 7 gauge cold formed steel mounting plates bolt to the leg columns.
- 1/2-13 x 1-1/2" long steel hex head bolts thread through the mounting plates and into steel inserts welded within the column.
- Each leg assembly fastens to the top with eight #14 x 3/4" long custom particle board screws.
- Tables greater than 72" have 2 bent steel rails screwed to the bottom of the top.

JOINTS

Continuous brazed welded for maximum strength.

FINISHES

Finished with powdercoat or optional chrome plating.



Folding Base

- **ST5T T-Base**
- **ST5C C-Leg**
- Self-supporting chassis made of two 1/8" thick L-shaped steel rails support the legs and folding mechanism.
- Rails act as stiffeners to resist top sag.
- Twin die cast zinc/aluminum diagonal braces are used as leg supports on ST5T Folding Series.
- Twin stamped steel braces are used on ST5T Folding Double end base Series.
- Latching devices will automatically engage to lock legs in their upright position.
- Folded thickness: 4-1/2".

DELUXE TRUCKS

- Saves wear and tear on tables.
- One person can set-up or knock down.
- Quiet, smooth movement on 6" diameter vulcanized rubber tired roller bearing casters.
- Load capacity 2,000 lbs.- up to six tables
- Finish is black enamel with carpeted bed.

SPECIFICATIONS

- Packed Weight: 115 lbs.
- 30"W x 42"L x 34"D
- Allowable total depth of tables: 26"



TKCEG

- \$1,637
- Recommended for folding tables up to 96" long
- Carpet over plywood



TDDEG

- \$1,637
- Recommended for round tables up to 60" diameter
- Carpet over steel

STANDARD TRUCKS

TFHGR

- \$1,426
- Recommended for folding tables up to 96" long
- Packed Weight: 175 lbs.
- 36"W x 99"L x 39-1/2"H
- Allowable total depth of tables: 18-36"
- Hardwood Platform

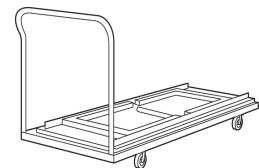

TFRGH

- \$1,482
- Recommended for Flip Top tables up to 48" long
- Packed Weight: 135 lbs.
- 36"W x 51"L x 39-1/2"H
- Allowable total depth of tables: 24-36"
- Plywood platform

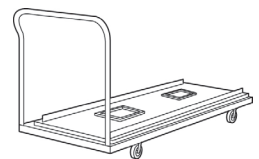

OPTIONS

FLIP TOP AND NESTING

- Allows the top to rotate into a vertical position for space saving when not in use
- Nesting width: approximately 9"

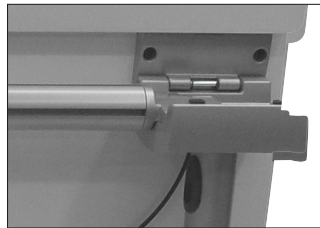
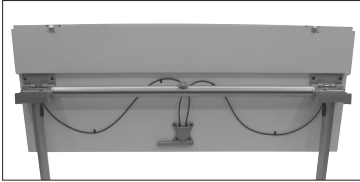

Flip Top/Nesting - Single Handle

- **ST6TN/ST6TNM Symmetrical Base**
- **ST6CN/ST6CNM Cantilever Base**
- Nests tightly reducing space requirements
- Single centered handle for easier top adjustment
- Stabilizing bar provides rigid support
- Available with Storm wheels or casters



Flip Top/Nesting - Double Handle

- **ST6X Pedestal Base**
- **ST6T T-Base**
- Top separates from base for added space savings.
- Mechanism is constructed of 7 gauge steel which hinges open in a clam shell fashion when a release handle is pulled.
- Latching devices will automatically engage when top is rotated back to its usable position.
- Casters not available.

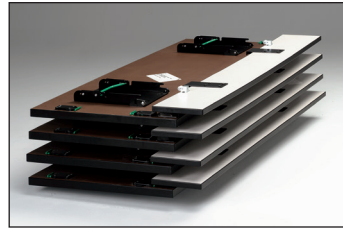

Butterfly Flip Mechanism

- **ST6TB Series**
- Top cannot be separated from base.
- Constructed with two cast aluminum arms. Spring loaded action to engage and release mechanism.
- Caster option available.

ADJUSTABLE HEIGHT

- Inner column and attached gear housing finished in black oxide
- Crank stores unobtrusively by telescoping in and up under top
- Standard crank placement is right side
- Lift rate: 9 cranks per inch of adjustment
- Maximum recommended lift capacity: 300 pounds



Adjustable Height T-Base

- **ST7T Series**
- Overall appearance similar to ST3T Stationary base table.
- 1-5/8" inner column telescopes out of 1-7/8" outer column.
- Leg assemblies are joined together with 1" x 2-1/2" 14 gauge steel trestle bar, finished in black powdercoat.
- Crank handle can be located on left or right side of table.
- Height range: 26" to 39".

Adjustable Height Split Top

- **ST7TS Series**
- Overall leg appearance similar to the ST3T Stationary "TT" base.
- 1-5/8" inner columns telescope out of 1-7/8" outer columns.
- Leg assemblies are joined together with 1" x 2-1/2" 14 gauge steel trestle bar, finished in black powdercoat.

- Has two tops; each top adjusts independently of the other.
- Rear top uses a removable crank handle mounted over top surface. Handle stores in bracket mounted under top.
- Front top has telescoping crank handle which stores by sliding up under top.
- Top widths: rear top 19", front top 16".
- Height range: 24" to 36".

Adjustable Height Pedestal Base ST7X Series

- Overall appearance similar to ST3X Stationary Series pedestal base.
- 2-5/8" inner column telescopes out of a 3" outer column.
- Height range: 26" to 39".

MODESTY PANELS

- Constructed of 3/4", 47 lb. density particle board conforming to ANCIA208.1
- Grade 1-M-S surfaced with .050" high pressure laminate, manufactured to NEMA standards.
- Edge material is 7/8" vinyl molding, PVC, or wood banding, and matches top edge color, PVC or wood banding. See Edge and Modesty Profiles



Clamp on modesty panels

- ST3T and ST6T Series
- Fastened to the leg with black finished clamps
- Individually packed and installed in the field
- Height 10"

Folding Modesty Panel

- ST5T Folding Table
- Permanently attached with hinges and catches
- Height 8"
- Shipped separately

Removable Modesty Panel

- ST5T Folding Table
- 18" wide tables have removable panels with slip hinges
- Panels must be removed before tables are folded
- Height 8"

GROMMETS

- Provides wire access through table top.
- Black plastic with snap-on covers.
- Two grommets installed per table.
- Single location must be specified left, right, or center using dimensions below for placement.



970801 - Round

- \$108 a pair
- Size: 2-5/16" Diameter (inside dimensions).
- Standard side location: 3-9/16" from back edge and 6-1/8" from each end.
- Standard center location: 2-7/8" from back edge and center of table length.



970812 - Oval

- \$114 a pair
- Size: 2-5/8" x 3-1/8" (inside dimensions).
- Standard side location: 3-5/16" from back edge and 6-1/8" from each end.
- Standard center location: 3-5/16" from back edge and center of table length.

WIRE MANAGEMENT



WL27 - Legway Wireway \$81

- Covers and routes wires up the table leg.
- Manager mounts on inside or outside of leg.
- Plastic clip holds legway against leg.
- Constructed of .047" thick, C-shaped aluminum extrusion.
- Finish: Powdercoat to match leg.
- Not available in polished chrome.
- Size: 1-3/4" wide x 7/8" deep.



WMB - Wire Mesh Bag

Available on tables with modesty panels

WMB36	36"	\$199
WMB48	48"	\$203
WMB60	60"	\$245
WMB72	72"	\$318
WMB84	84"	\$351
WMB90	90"	\$392

GANGING

- Set of locks is two male, two female, half set installed on both ends of top.

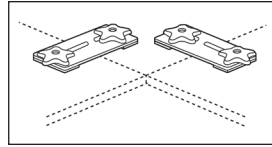

QL Quick Lock Ganging Mechanism Factory installed

QL1 1 1/4" Top \$168

QL2 1 3/4" Top \$168

- Must be ordered with table.
- Specify ganging configuration, e.g. end to end, side to end, side to side, etc

Customer installed.

QL1 1 1/4" Top \$90

QL2 1 3/4" Top \$90

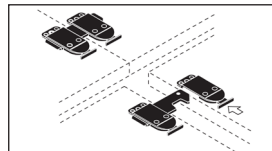

FL-4 Fast Lock Ganging Mechanism \$120

- Factory installed — must be ordered with table.
- Gangs tables and bridges end-to-end.
- Must be used on 1-1/4" tables only

UNIVERSAL WIRE MANAGER



UWMA48 48" \$610

UWMA60 60" \$667

UWMA72 72" \$715

- ST5 and ST3 Series
- The Universal Wire Manager can be added in the field.
- Wire Manager must be removed before table is folded.
- Not available on: round, racetrack, quarter round, half-round or crescent shapes.

MOBILITY

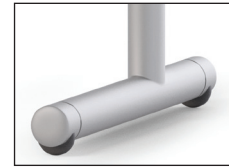

STORM WHEEL - \$135

- Must be ordered with table.
- Replaces two end caps in one end of an end base table up to 96".
- Color: Black plastic.

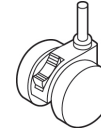

451056 - Dual Wheel Locking Casters \$157 (set of 4)

- 2-1/2" Diameter
- If ordered with table will not increase table height.
- If retrofitted will increase table height 2".
- Color: Black plastic.
- Available only on: ST6X, ST6TB, ST6TN/ST6TNM and ST6CN/ST6CNM Stationary, Butterfly Flip and Folding Tables.

STABILIZING GLIDES

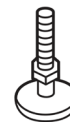

241111 \$5

- Spring loaded automatically adjusts to floor variances up to 3/8".
- Price is for one glide.

JURY BASE

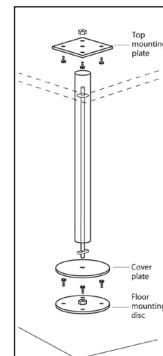

J15BD Jury Base Round Column

J15BD-12 \$534

J15BD-18 \$673

J15BD-22 \$833

J15BD-26 \$896

- Floor mounted base
- Column: 3-1/2" 16 gauge
- Floor mount: disc bolts in place
- 18 gauge spun steel cover fits over mounting disc to hide mounting hardware
- 1/2" threaded tie rod bolts to floor mounting disc
- Column ties cover rod
- Tie Rod attaches top plate to column
- Top mounting plate 10" x 10" x 7 gauge cold formed steel
- Finish: Powdercoat
- Table Height: 29"

Recommended mounting hardware (not supplied):

Wood floors:

1/2" x 3-1/2" long lag bolts.

Masonry floors:

1/2-13 x 4" hex head cap

screw with female masonry anchor

FINISHES

Additional standard and optional finishes available at falconproducts.com

Wood Colors



Metal Powdercoat Colors

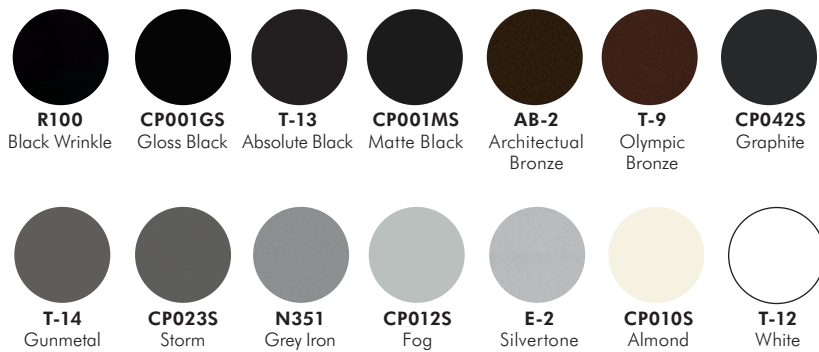

Vinyl Edges Colors Not all colors available on every edge profile. Visit falconproducts.com for more information.

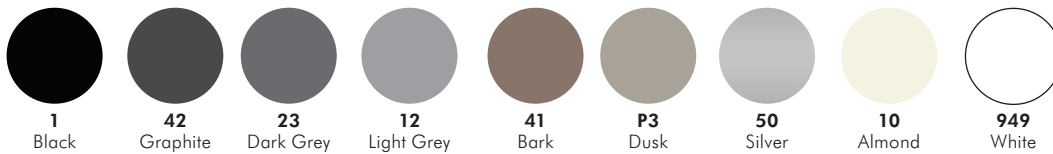

FALCONTM

SYNTECHTM TABLES

WORKBOOK/PRICE LIST August 2015

DELIVERED TO ZONE 1, ADD + 4% DELIVERED TO ZONE 2



- Cantilever Leg
- Grade 3 powdercoat standard, Grade 1 laminate standard
- Add On Tables include one set GA2 gangers
- When using Add On Tables, gangers required on Starter Tables, order must specify, add \$148 per table
- Several optional power solutions available

**25OCS
STARTER**



Wood Edges
Only

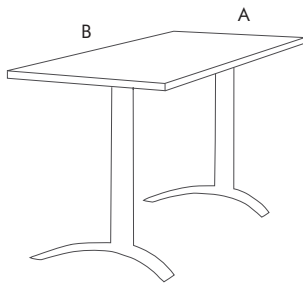

Table Size (A x B)	13500 / 13333 / 1440	23000	24000	4720 Postform	Veneer Upcharge
24 x 48	753	818	998	856	309
24 x 54	864	939	1,049	979	347
24 x 60	996	1,081	1,058	1,128	385
24 x 72	1,223	1,326	1,124	1,260	463
30 x 48	776	844	1,041	882	231
30 x 54	910	990	1,069	1,033	434
30 x 60	1,029	1,115	1,081	1,162	482
30 x 72	1,223	1,325	1,144	1,306	579

**25OCA
ADD ON**



Wood Edges
Only

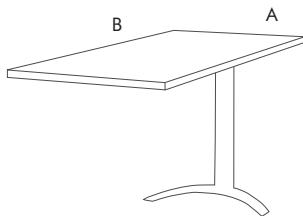

Table Size (A x B)	13500 / 13333 / 1440	23000	24000	4720 Postform	Veneer Upcharge
24 x 48	609	670	855	712	309
24 x 54	721	791	905	834	347
24 x 60	853	932	913	984	385
24 x 72	1,079	1,178	979	1,115	463
30 x 48	630	696	898	737	231
30 x 54	768	843	927	888	434
30 x 60	884	968	937	1,018	482
30 x 72	1,079	1,177	998	1,161	579

- Cantilever Leg
- Includes 8" Modesty Panel.
- Grade 3 powdercoat standard, Grade 1 laminate standard
- Add On Tables include one set GA2 gangers
- When using Add On Tables, gangers required on Starter Tables, order must specify, add \$148 per table
- Several optional power solutions available

250CSM STARTER W/MODESTY



Wood Edges
Only

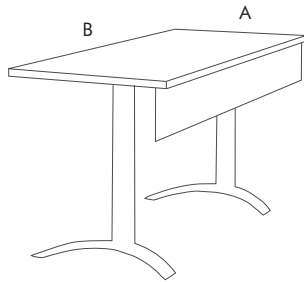

Table Size (A x B)	13500 / 13333 / 1440	23000	24000	4720 Postform	Veneer Upcharge
24 x 48	891	831	1,137	993	463
24 x 54	1,000	936	1,187	1,115	521
24 x 60	1,134	1,059	1,195	1,265	579
24 x 72	1,360	1,271	1,261	1,398	694
30 x 48	912	853	1,180	1,018	385
30 x 54	1,048	980	1,206	1,170	608
30 x 60	1,165	1,089	1,218	1,300	675
30 x 72	1,360	1,270	1,281	1,444	811

250CAM ADD ON W/MODESTY



Wood Edges
Only

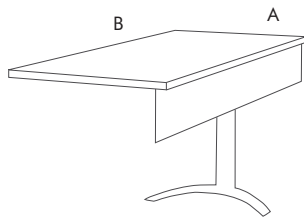

Table Size (A x B)	13500 / 13333 / 1440	23000	24000	4720 Postform	Veneer Upcharge
24 x 48	745	703	992	849	463
24 x 54	857	808	1,042	973	521
24 x 60	990	931	1,052	1,120	579
24 x 72	1,216	1,143	1,115	1,253	694
30 x 48	768	725	1,035	874	385
30 x 54	904	852	1,063	1,025	608
30 x 60	1,021	960	1,074	1,155	675
30 x 72	1,216	1,142	1,137	1,299	811

KRYSTALCAST MODESTY PANEL



Panel Size (A x B)	Price
7 x 42	395
7 x 48	416
7 x 60	438
7 x 72	459

- Frosted or Solid color, same pricing.

- Symmetrical and Cantilever Legs
- 25NSM AND 25NCM Include 8" Modesty Panel
- Grade 3 powdercoat standard, Grade 1 laminate standard
- Convenient single center handle
- Stabilizing bar increases stability
- Several optional power solutions available
- Casters optional



Casters
Available for Symmetrical
and Cantilever Legs
\$135/set of 4

**25NS (SYMMETRICAL)
25NC(CANTILEVER)
FLIP/NESTING**

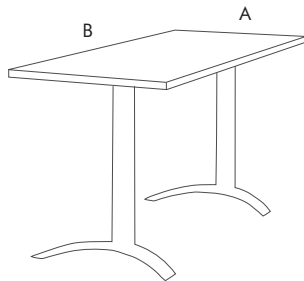

Table Size (A x B)	13500 / 13333 / 1440	23000	24000	4720 Postform
24 X 42	936	976	1,146	1,024
24 x 48	1,066	1,111	1,312	1,169
24 x 60	1,310	1,367	1,370	1,441
24 x 72	1,535	1,606	1,438	1,573
30 X 42	954	994	1,183	1,044
30 x 48	1,089	1,137	1,355	1,194
30 x 60	1,342	1,401	1,395	1,475
30 x 72	1,535	1,605	1,457	1,620

**25NSM (SYMMETRICAL)
25NCM (CANTILEVER)
FLIP/NESTING
WITH MODESTY
PANEL**

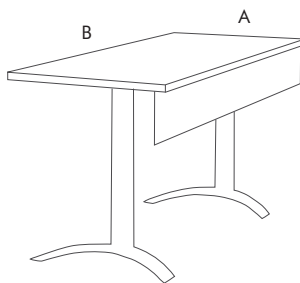

Table Size (A x B)	13500 / 13333 / 1440	23000	24000	4720 Postform
24 X 42	1,073	1,112	1,283	1,160
24 x 48	1,203	1,248	1,449	1,306
24 x 60	1,447	1,505	1,508	1,577
24 x 72	1,673	1,744	1,574	1,711
30 X 42	1,092	1,132	1,319	1,183
30 x 48	1,226	1,273	1,492	1,330
30 x 60	1,479	1,538	1,531	1,613
30 x 72	1,673	1,743	1,593	1,757

MEETING AND CONFERENCE TABLES

- Includes Symmetrical legs
- Grade 3 powdercoat standard, Grade 1 laminate standard
- Several optional power solutions available
- Does not include Modesty Panel

25SS RECTANGLE



Table Size (A x B)	Bases	Base Size	13500 / 13333 / 1440	23000	24000 / 24022 / 24055	38350	Veneer Upcharge
30 x 60	2	22	955	1,020	1,185	1,315	482
30 x 72	2	22	1,148	1,175	1,421	1,579	579
30 x 84	2	22	1,338	1,369	1,658	1,841	675
30 x 96	2	22	1,528	1,565	1,893	2,103	772
30 x 120	3	22	1,913	1,957	2,368	2,629	965
36 x 60	2	22	1,147	1,175	1,421	1,577	579
36 x 72	2	22	1,376	1,409	1,707	1,893	694
36 x 84	2	22	1,606	1,644	1,989	2,210	811
36 x 96	2	22	1,835	1,878	2,272	2,523	927
36 x 120	3	22	2,292	2,348	2,840	3,155	1,157

MEETING AND CONFERENCE TABLES

- Includes Symmetrical legs
- Grade 3 powdercoat standard, Grade 1 laminate standard
- Does not include Modesty Panel
- Several optional power solutions available

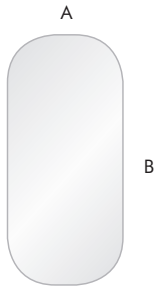

25SS RACETRACK



Wood Edges Only

Table Size (A x B)	Bases	Base Size	13500 / 13333 / 1440	23000	24000 / 24022 / 24055	38350	Veneer Upcharge
30 x 60	2	22	1,069	1,097	1,326	1,473	482
30 x 72	2	22	1,285	1,315	1,591	1,768	579
30 x 84	2	22	1,499	1,534	1,854	2,061	675
30 x 96	2	22	1,712	1,753	2,121	2,356	772
30 x 120	3	22	2,141	2,191	2,652	2,946	965
36 x 60	2	22	1,284	1,315	1,591	1,767	579
36 x 72	2	22	1,541	1,580	1,911	2,121	694
36 x 84	2	22	1,798	1,842	2,229	2,474	811
36 x 96	2	22	2,054	2,103	2,544	2,827	927
36 x 120	3	22	2,568	2,629	3,182	3,532	1,157



25MC MEDIA CONFERENCE



Wood Edges Only

Table Size (A x B)	Bases	Base Size	13500 / 13333 / 1440	23000	24000 / 24022 / 24055	38350	Veneer Upcharge
24 x 36 x 72	2	22	1,283	948	1,148	1,800	694
24 x 36 x 90	2	22	1,604	1,185	1,433	2,209	868
24 x 36 x 108	2	22	1,924	1,421	1,719	2,650	1,041
24 x 36 x 120	3	22	2,139	1,579	1,911	2,945	1,157

MULTI-SURFACE MEETING TABLES (SPECIALTY SHAPES)

- Includes Symmetrical Shared legs, three per network pod
- Grade 3 powdercoat standard, Grade 1 laminate standard
- Does not include Modesty Panel
- Several optional power solutions available
- Pricing is for complete Network Pod Unit of three tables with bases

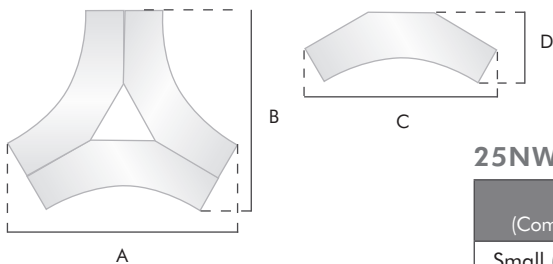

25NW NETWORK POD



Wood Edges Only

Table Size (Complete A x B) (Single C x D)	13500 / 13333	23000	Veneer Upcharge
Small (80 x 69.75) (67.25 x 24)	3,752	3,100	1,312
Large (93 x 107) (89.75 x 32.5)	4,969	4,107	2,353

MULTI-SURFACE MEETING TABLES (SPECIALTY SHAPES)

- Does not include Modesty Panel
- Grade 3 powdercoat standard, Grade 1 laminate standard
- Several optional power solutions available

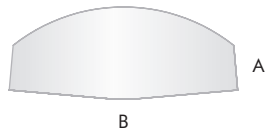

25CCE CURVED END



Wood Edges Only

Table Size (A x B)	13500 / 13333 / 1440	23000	Veneer Upcharge
30 x 72	1,408	1,164	579

- Includes two Cantilever legs and one set of Gangers
- Connects to 30" starter tables with standard modesty panel
- Starter tables may also be ordered without modesty

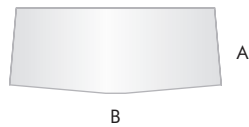

25CSE STRAIGHT END



Wood Edges Only

Table Size (A x B)	13500 / 13333 / 1440	23000	Veneer Upcharge
30 x 72	1,365	1,129	579

- Includes two Cantilever legs and one set of Gangers
- Connects to 30" starter tables with standard modesty panel
- Starter tables may also be ordered without modesty

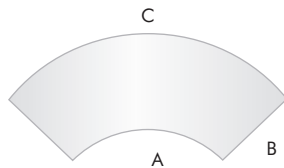

25CCR CRESCENT CONNECTOR



Wood Edges Only

Table Size (A x B x C)	13500 / 13333	23000	Veneer Upcharge
36R x 24 x 56	1,157	957	772
48R x 24 x 75	1,241	1,026	1,157
36R x 30 x 56	1,196	988	733
48R x 30 x 75	1,275	1,055	1,157

- Includes two Cantilever legs and one set of Gangers



25CHR HALF ROUND



Wood Edges Only

Table Size	13500 / 13333 / 1440	23000	Veneer Upcharge
60D	1,519	1,256	482
72D	1,897	1,569	694

- Includes two Cantilever legs and one set of Gangers.



25C45 45° CONNECTOR



Wood Edges Only

Table Size	13500 / 13333 / 1440	23000	Veneer Upcharge
24D	384	318	305
30D	395	326	363

- No Bases
- Includes one set of Gangers



25C90 90° CONNECTOR



Wood Edges Only

Table Size	13500 / 13333 / 1440	23000	Veneer Upcharge
24D	817	675	478
30D	939	776	546

- No Bases
- Includes one set of Gangers

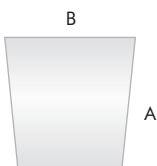

25CW WEDGE CONNECTOR



Wood Edges Only

Table Size (A x B)	13500 / 13333 / 1440	23000	Veneer Upcharge
24 x 29	358	295	189
30 x 30	466	384	242

- No Bases
- Includes one set of Gangers

STANDARD FEATURES

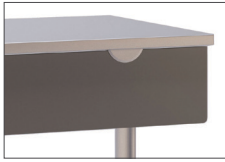

Modesty Panel

- Standard on 24" and 30" Training Tables
- Standard any Grade 1 laminate
- Modesty hardware matches base finish
- Optional perforated modesty
- KrystalCast Modesty



Cantilever Shared Leg



Wireway Leg

- (-P) Suffix for One Column
- (-PP) Suffix for Two Column
- One leg, specify right or left placement as seen from user side.

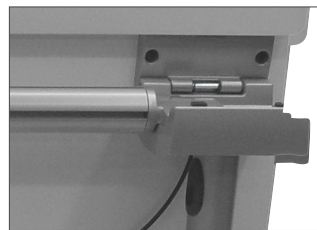

Flip/Nesting Table

- 25NS (Symmetrical) + 25NC(Cantilever)
- 25NSM (Symmetrical) + 25NCM (Cantilever)
- Symmetrical and Cantilever Legs
- Convenient single center handle
- Stabilizing bar increases stability
- Several optional power solutions available
- Casters optional

OPTIONS



Casters

Available for Symmetrical and Cantilever Legs
\$135/set of 4



Cantilever Base Only (22")
 250V-322C **\$297** GD3



Symmetrical Base Only
 250V-18S **\$297** GD3
 250V-322S **\$297** GD3



24" Mesh Wireway Bag
\$111



GRM3 & GRM2
 Grommet
\$82

See "Power Solutions" section for additional power options.

X Base Only (22")

- 250X-22 **\$400** GD1
- 250X-22 **\$461** GD2
- 250X-22 **\$482** GD3

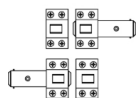

GA2 Gangers

Starter tables require gangers if Add On units purchased
\$148/set

Small Order Charge: Orders with a combined Net price under \$1,000 will be subject to a Special Handling Charge of \$125 Net. One charge per order.

FLX POWER MANAGEMENT

Power is mounted in the middle of the table, allowing column to act as a vertical wire manager.



FLX Power Management is an upcharge to the table base price:

- Cord exits under base plate add **\$346** list
- Cord exits through column side add **\$346** list
- Must be specified on table base order FLX may be used on cocktail, dining, counter, and bar height versions of approved bases.

TABLE TOP EDGE PROFILES



13500 1.25" fluted vinyl edge. High pressure laminate top standard with 3" radius corners. Available in a variety of colors



13333 1.25" solid vinyl flat T mold edge. High pressure laminate top standard with 1" radius corners. Available in a variety of colors



1440 1.25" flat PVC edge band. High pressure laminate. Radius corners not available



23000 1.25" x .25" wood banded edge high pressure laminate or veneer top surface



24000 1.25" x 1.25" square wood edge high pressure laminate, veneer, or Veneer Art top surface



24022 1.25" x 1.25" half bullnose wood edge high pressure laminate, veneer, or Veneer Art top surface



24055 1.25" x 1.25" full bullnose wood edge high pressure laminate, veneer, or Veneer Art top surface



38350 1.25" x 2" beveled wood edge with high pressure laminate, veneer, or Veneer Art top surface.

FALCON™

SYMETRIS™ TABLES

WORKBOOK/PRICE LIST August 2015

DELIVERED TO ZONE 1, ADD + 4% DELIVERED TO ZONE 2



- Cantilever Leg
- Grade 3 Powdercoat Standard, Grade 1 Laminate Standard
- Several optional power solutions available
- Modesty/Wire Gallery
- Vertical Wire Management

**36S
STARTER**

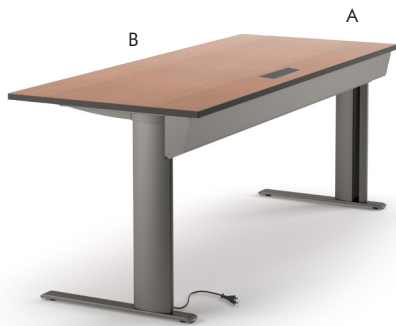

Table Size (A x B)	13500 / 13333 / 1440 / 1446	4150	4160	4720 Postform
24 x 42	993	1,131	1,121	1,009
24 x 48	1,023	1,144	1,137	1,023
24 x 60	1,118	1,245	1,237	1,113
24 x 72	1,191	1,322	1,313	1,186
30 x 42	1,009	1,151	1,143	1,009
30 x 48	1,043	1,164	1,156	1,038
30 x 60	1,155	1,282	1,272	1,150
30 x 72	1,238	1,369	1,359	1,227

- Optional upper screens available with 4150 or 4720 edge

**36A
ADD ON**

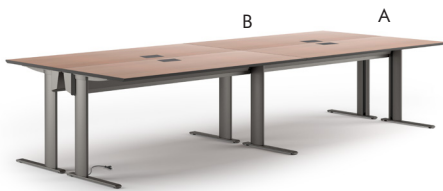

Table Size (A x B)	13500 / 13333 / 1440 / 1446	4150	4160	4720 Postform
24 x 42	760	896	889	775
24 x 48	789	909	902	789
24 x 60	886	1,011	1,002	879
24 x 72	957	1,089	1,080	952
30 x 42	775	917	908	775
30 x 48	811	931	924	805
30 x 60	923	1,049	1,039	917
30 x 72	1,005	1,137	1,126	994

- Symmetrical and Cantilever Legs
- 36NSM and 36NCM Include 8" Modesty Panel
- Grade 3 Powdercoat Standard, Grade 1 Laminate Standard
- Convenient single center handle
- Several optional power solutions available
- Casters optional
- Optional wire way leg.



Casters
Available for Symmetrical
and Cantilever Legs
\$155/set of 4

36NSM (SYMMETRICAL) 36NCM (CANTILEVER) FLIP/NESTING WITH MODESTY PANEL



Table Size (A x B)	13500 / 13333 / 1440 / 1446	4150	4160	4720 Postform
24 x 42	1,460	1,622	1,587	1,489
24 x 48	1,500	1,667	1,630	1,530
24 x 60	1,580	1,755	1,717	1,611
24 x 72	1,659	1,844	1,804	1,693
30 x 42	1,540	1,711	1,674	1,571
30 x 48	1,580	1,755	1,717	1,611
30 x 60	1,659	1,844	1,804	1,693
30 x 72	1,739	1,933	1,891	1,775

KRYSTALCAST MODESTY PANEL



Panel Size (A x B)	Price
7 x 42	395
7 x 48	416
7 x 60	438
7 x 72	459

- Frosted or Solid color, same pricing.

36NS (SYMMETRICAL) 36NC (CANTILEVER) FLIP/NESTING



Table Size (A x B)	13500 / 13333 / 1440 / 1446	4150	4160	4720 Postform
24 x 42	1,419	1,581	1,546	1,448
24 x 48	1,459	1,626	1,589	1,489
24 x 60	1,539	1,714	1,676	1,570
24 x 72	1,608	1,793	1,753	1,642
30 x 42	1,488	1,659	1,623	1,520
30 x 48	1,528	1,704	1,666	1,560
30 x 60	1,608	1,793	1,753	1,642
30 x 72	1,678	1,872	1,830	1,714

- Cantilever Leg
- Grade 3 Powdercoat Standard, Grade 1 Laminate Standard
- Lower Modesty Panel
- Locking File Cabinet in Storm or Black Finish
- Optional Upper Screens Available

**36TD
TEACHERS
DESK**



Table Size (A x B)	13500 / 13333 / 1440	4150	4720 Postform
30 x 48	1,812	1,933	1,807
30 x 60	1,942	2,069	1,937
30 x 72	2,052	2,184	2,042

41LD - FREESTANDING/STARTER

Table Size	Screen Size	11" Height	17" Height
24 x 30	19 x 30	517	600
24 x 36	19 x 36		
24 x 42	19 x 42		
30 x 30	25 x 30		
30 x 36	25 x 36		
30 x 42	25 x 42	550	645
24 x 48	19 x 48		
24 x 54	19 x 54		
24 x 60	19 x 60		
30 x 48	25 x 48		
30 x 54	25 x 54	580	674
30 x 60	25 x 60		
24 x 72	19 x 72	580	674
30 x 72	25 x 72		

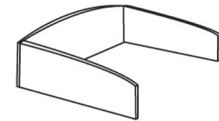

ACTIVE LEARNING TABLE

- Includes 3 Symmetrical Shared legs
- Grade 3 powdercoat standard, Grade 1 laminate standard
- 29" Standard Overall Height
- Several optional power solutions available
- Pricing is for complete Active Learning Table
- Screens available with 4150 or 4720 Edge



36POD ACTIVE LEARNING TABLE



Table Size (Complete A x B) (Single C x D)	Weight	13500 / 13333
59.33 x 68.5 27" Outer Surface. 42" Inner surface	160 lbs.	1,705

400 SERIES



22 x 22
30 x 30

- Cast Iron Baseplate
- Powdercoat Finish
- 16 GA 3" Round Steel Column
- 10 x 10 Steel Spider, Black
- MPT1 Nylon Glides

OPTIONS

- \$27** Upcharge, per base set up
- \$5** Super Leveler Glides
- \$48** Per column/up to 40.75" greater than standard height (STU)
- \$49** Per column/counter height 34.75" (CH)
- \$49** Per column/wheelchair height 30" (W)
- \$19** Per column/cocktail height 16.75" (C)
- \$166** Per column standard height with wire management
- \$214** Per column/up to 40.75" greater than standard height with wire management
- \$198** Per column/wheelchair height 30" with wire management
- \$188** Per column/cocktail height 16.75" with wire management

Catalog Number	Base Spread	Spider Spread	Col. Dia.	Apprx WT	Overall Height	Grade 1	Grade 2	Grade 3
403-22	22 x 22	10	3	31	28	308	314	330
403-30	30 x 30	10	3	36	28	356	364	382

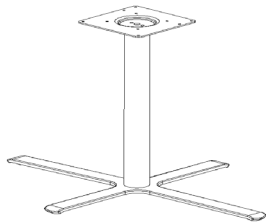

22 x 30

RECOMMENDED BASE BY TABLE TOP SIZE USING STANDARD FALCON CORE TOPS.

(Larger or heavier tops may cause instability).

Top Size	400 Series
30 Round	403-22
36 Round	403-22
42 Round	403-30
30 x 30	403-22
36 x 36	403-30
42 x 42	403-30

Top Size	400 Series
24 x 30	403-22
24 x 36	403-22
24 x 42	403-2230
30 x 36	403-22
30 x 42	403-2230
30 x 60	403-22 +

Top Size	400 Series
30 x 72	403-22 +
30 x 84	403-22 +
30 x 96	403-22 +
30 x 108	403-22++
30 x 120	403-22 ++
30 x 144	403-22 ++
36 x 42	403-2230
36 x 48	403-22 +
36 x 54	403-22 +
36 x 60	403-30 +
36 x 72	403-30 +
36 x 84	403-30 +
36 x 96	403-30 +
36 x 108	403-30 ++
36 x 120	403-30 ++
36 x 144	403-30 ++

+ = Two bases per top required

++ = Three bases per top required

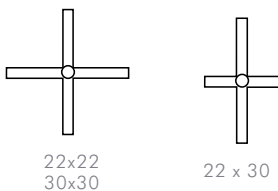

22x22
30x30

22 x 30

FLX POWER MANAGEMENT

Power is mounted in the middle of the table, allowing column to act as a vertical wire manager.

FLX Power Management is an upcharge to the table base price:

Cord exits under base plate add **\$346** list

Cord exits through column side add **\$346** list

Must be specified on table base order FLX may be used on cocktail, dining, counter, and bar height versions of approved bases.



FALCON™

MEETING AND CONFERENCE TABLES

WORKBOOK/PRICE LIST August 2015

DELIVERED TO ZONE 1, ADD + 4% DELIVERED TO ZONE 2



74PT EXCHANGE COMMUNITY TABLE

- Grade 1 Standard Laminate - Formica or Wilsonart only
- Also available in Veneer-Art® and ColorCore® (see below)
- Optional power available (see below)



How to order:

74PT3096SH
29" Task Height

74PT3096CH
36" Active Height

74PT3096BH
42" Active Height

Table Size	Task Height 29"	Apprx. Weight	Active Height 36"	Apprx. Weight	Active Height 42"	Apprx. Weight
30 x 72	3,171	300	3,388	348	3,809	390
30 x 84	3,541	336	3,804	389	4,293	435
30 x 96	3,575	373	3,838	431	4,328	481
36 x 72	3,359	339	3,564	392	4,009	437
36 x 84	3,746	380	3,996	437	4,509	487
36 x 96	3,780	420	4,031	482	4,544	536
42 x 72	3,706	379	3,878	436	4,368	485
42 x 84	4,150	423	4,424	485	4,925	538
42 x 96	4,185	467	4,458	534	4,970	591
48 x 72	3,724	418	3,894	480	4,384	533
48 x 84	4,168	466	4,441	532	4,943	590
48 x 96	4,201	514	4,475	590	4,976	646

LAMINART VENEER-ART

Apprx. Weight (same as above)

Table Size	Standard Height 29"	Counter Height 36"	Community Height 42"
30 x 72	19,444	19,677	20,122
30 x 84	19,849	20,116	22,966
30 x 96	22,188	22,455	22,999
36 x 72	19,633	19,855	20,333
36 x 84	20,066	20,322	23,205
36 x 96	22,405	22,661	23,238
42 x 72	20,005	20,205	23,727
42 x 84	22,799	23,088	23,655
42 x 96	22,833	23,122	23,699
48 x 72	22,327	22,527	23,049
48 x 84	22,816	23,105	25,983
48 x 96	25,161	25,449	26,016

FORMICA COLORCORE

Apprx. Weight (same as above)

Table Size	Standard Height 29"	Counter Height 36"	Community Height 42"
30 x 72	9,930	10,170	10,625
30 x 84	10,346	10,620	12,118
30 x 96	11,320	11,594	12,151
36 x 72	10,124	10,351	10,841
36 x 84	10,569	10,830	12,363
36 x 96	11,543	11,804	12,396
42 x 72	10,505	10,710	11,246
42 x 84	11,946	12,243	12,824
42 x 96	11,980	12,276	12,869
48 x 72	11,463	11,668	12,203
48 x 84	11,964	12,260	13,780
48 x 96	12,938	13,234	13,814

Formica ColorCore

- 7223 New White
- 909 Black
- 961 Fog
- 927 Folkstone
- 923 Surf
- 845 Spectrum Red
- 932 Antique White
- 933 Mission White
- 949 White

Power Options Available:

- EXP2 (MHO)
- Axil Z
- Glenbeigh

SYNTECH™

MEETING AND CONFERENCE TABLES

- Includes Symmetrical legs
- Grade 3 powdercoat standard, Grade 1 laminate standard
- Wood Edges and Veneer are Maple Species (veneer is long grain)
- Oak Edges and Veneer are available at the same price, specify on order
- Several optional power solutions available, see Power Solutions Section



25SS RECTANGLE



Wood Edges Only



Table Size	Bases	Base Size	13500 / 13333 / 1440	23000	24000 / 24022 / 24055	38350	Veneer Upcharge
30 x 60	2	22	955	1,138	1,185	1,315	482
30 x 72	2	22	1,148	1,364	1,421	1,579	579
30 x 84	2	22	1,338	1,591	1,658	1,841	675
30 x 96	2	22	1,528	1,817	1,893	2,103	772
30 x 120	3	22	1,913	2,272	2,368	2,629	965
36 x 60	2	22	1,147	1,363	1,421	1,577	579
36 x 72	2	22	1,376	1,637	1,707	1,893	694
36 x 84	2	22	1,606	1,911	1,989	2,210	811
36 x 96	2	22	1,835	2,183	2,272	2,523	927
36 x 120	3	22	2,292	2,728	2,840	3,155	1,157

25SS RACETRACK



Wood Edges Only



Table Size	Bases	Base Size	13500 / 13333 / 1440	23000	24000 / 24022 / 24055	38350	Veneer Upcharge
30 x 60	2	22	1,069	1,273	1,326	1,473	482
30 x 72	2	22	1,285	1,528	1,591	1,768	579
30 x 84	2	22	1,499	1,784	1,854	2,061	675
30 x 96	2	22	1,712	2,035	2,121	2,356	772
30 x 120	3	22	2,141	2,544	2,652	2,946	965
36 x 60	2	22	1,284	1,527	1,591	1,767	579
36 x 72	2	22	1,541	1,835	1,911	2,121	694
36 x 84	2	22	1,798	2,140	2,229	2,474	811
36 x 96	3	22	2,054	2,445	2,544	2,827	927
36 x 120	3	22	2,568	3,055	3,182	3,532	1,157

25MC MEDIA CONFERENCE



Wood Edges Only



Table Size	Bases	Base Size	13500 / 13333 / 1440	23000	24000 / 24022 / 24055	38350	Veneer Upcharge
24 x 36 x 72	2	22	1,283	1,103	1,148	1,800	694
24 x 36 x 90	2	22	1,604	1,378	1,433	2,209	868
24 x 36 x 108	2	22	1,924	1,654	1,719	2,650	1,041
24 x 36 x 120	3	22	2,139	1,838	1,911	2,945	1,157

CURV™

MEETING AND CONFERENCE TABLES

- Available in three heights, with square or round columns, specify on order
- Grade 3 powdercoat, Grade 1 laminate standard
- Wood Edges and Veneer are Maple Species (veneer is long grain)
- Oak Edges and Veneer are available at the same price, specify on order
- Several optional power solutions available, see Power Solutions Section
- Optional Wireway Leg



Available with square column



65CV-CT ROUND



Wood Edges Only

Table Size	Bases	Base Size	13500 / 13333 / 1440			24000 / 24055			38350			Veneer Upcharge	Polished Chrome Upcharge		
			29.5"	36"	42"	29.5"	36"	42"	29.5"	36"	42"		29.5"	36"	42"
42 Round	4	3"	894	1,069	1,156	1,420	1,596	1,682	1,300	1,475	1,562	473	156	165	199
48 Round	4	3"	946	1,121	1,208	1,598	1,773	1,860	1,440	1,615	1,703	617	156	165	199
60 Round	4	3"	1,102	1,277	1,364	1,722	1,897	1,984	1,586	1,762	1,848	965	156	165	199



65CV-CT SQUARE



Wood Edges Only

Table Size	Bases	Base Size	13500 / 13333 / 1440			24000 / 24055			38350			Veneer Upcharge	Polished Chrome Upcharge		
			29.5"	36"	42"	29.5"	36"	42"	29.5"	36"	42"		29.5"	36"	42"
42 Square	4	3"	849	1,025	1,111	1,349	1,525	1,612	1,235	1,410	1,498	473	156	165	199
48 Square	4	3"	899	1,075	1,161	1,517	1,693	1,780	1,367	1,544	1,630	617	156	165	199
60 Square	4	3"	1,047	1,223	1,310	1,636	1,812	1,898	1,507	1,682	1,769	965	156	165	199

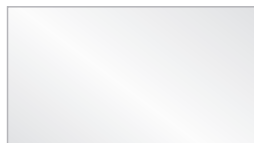

65CV-CT RECTANGULAR



Wood Edges Only

Table Size	Bases	Base Size	13500 / 13333 / 1440			24000 / 24055			38350			Veneer Upcharge	Polished Chrome Upcharge		
			29.5"	36"	42"	29.5"	36"	42"	29.5"	36"	42"		29.5"	36"	42"
36 x 60	4	3"	935	1,110	1,197	1,290	1,466	1,553	1,337	1,512	1,599	579	156	165	199
36 x 72	4	3"	1,022	1,197	1,284	1,420	1,596	1,682	1,491	1,667	1,754	694	156	165	199

CURV™

MEETING AND CONFERENCE TABLES

- Available in three heights, with square or round columns, specify on order
- Grade 3 powdercoat, Grade 1 laminate standard
- Wood Edges and Veneer are Maple Species (veneer is long grain)
- Oak Edges and Veneer are available at the same price, specify on order
- Several optional power solutions available, see Power Solutions Section
- Optional Wireway Leg

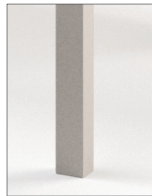

Available with square columns



65CV-CT CONFERENCE



Wood Edges Only

Table Size (A x C x B)	Bases	Base Size	13500 / 13333 / 1440			24000 / 24055			38350			Veneer Upcharge	Polished Chrome Upcharge		
			29.5"	36"	42"	29.5"	36"	42"	29.5"	36"	42"		29.5"	36"	42"
36 x 72 x 48	4	3"	1,446	1,622	1,709	1,640	1,816	1,902	1,729	1,904	1,992	927	156	165	199
36 x 90 x 48	4	3"	1,561	1,737	1,825	1,806	1,981	2,068	1,919	2,094	2,181	1,157	156	165	199
36 x 108 x 48	6	3"	2,096	2,360	2,491	2,390	2,654	2,784	2,523	2,786	2,917	1,389	229	243	292
36 x 120 x 48	6	3"	2,173	2,436	2,567	2,499	2,762	2,894	2,649	2,912	3,042	1,544	229	243	292



65CV-WA WAVE



Wood Edges Only

Table Size	Bases	Base Size	13500 / 13333 / 1440			15300			Veneer Upcharge	Polished Chrome Upcharge		
			29.5"	36"	42"	29.5"	36"	42"		29.5"	36"	42"
36 x 58	4	3"	1,066	1,242	1,328	1,262	1,439	1,525	656	156	165	199

J91CT

MEETING AND CONFERENCE TABLES

- Grade 3 powdercoat, Grade 1 laminate standard
- Wood Edges and Veneer are Maple Species (veneer is long grain)
- Oak Edges and Veneer are available at the same price, specify on order
- Several optional power solutions available, see Power Solutions Section



J91CT ROUND



Table Size	Bases	Base Size	1333	1344	2400 / 2405 / 3810	2600 / 2605	Veneer Upcharge	Polished Chrome Upcharge
42 Round	1	22"	1,070	1,087	1,546	1,741	473	165
48 Round	1	26"	1,281	1,300	1,828	2,053	617	199



J91CT SQUARE



Table Size	Bases	Base Size	1333	1344	2400 / 2405 / 3810	2600 / 2605	Veneer Upcharge	Polished Chrome Upcharge
42 Square	1	22"	1,110	1,129	1,434	1,601	473	165
48 Square	1	26"	1,326	1,348	1,654	1,837	617	199

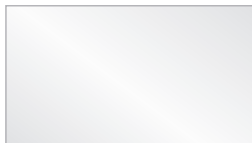

J91CT RECTANGULAR



Table Size	Bases	Base Size	1333	1344	2400 / 2405 / 3810	2600 / 2605	Veneer Upcharge	Polished Chrome Upcharge
36 x 72	2	22"	2,047	2,073	2,249	2,428	694	330
36 x 84	2	22"	2,106	2,137	2,440	2,665	811	330
36 x 96	2	22"	2,108	2,139	2,447	2,674	927	330
36 x 120	3	22"	2,246	2,284	2,672	2,958	1,157	495
36 x 144	3	22"	3,157	3,202	3,670	4,012	1,389	495
42 x 72	2	26"	2,637	2,677	3,084	3,394	811	397
42 x 84	2	26"	2,690	2,734	3,101	3,414	945	397
42 x 96	2	26"	2,742	2,788	3,111	3,426	1,080	397
42 x 120	3	26"	4,010	4,073	4,411	4,823	1,351	595
42 x 144	3	26"	4,254	4,333	4,754	5,252	1,621	595
48 x 72	2	26"	2,344	2,370	2,971	3,252	927	397
48 x 84	2	26"	2,742	2,788	3,126	3,446	1,080	397
48 x 96	2	26"	2,804	2,856	3,143	3,468	1,235	397
48 x 120	3	26"	4,084	4,153	4,488	4,918	1,544	595
48 x 144	3	26"	4,206	4,280	4,845	5,365	1,851	595

Note: 144" Ships in 2 pieces

J91CT

MEETING AND CONFERENCE TABLES

- Grade 3 powdercoat, Grade 1 laminate standard
- Wood Edges and Veneer are Maple Species (veneer is long grain)
- Oak Edges and Veneer are available at the same price, specify on order
- Several optional power solutions available, see Power Solutions Section



J91CT RACETRACK



Table Size	Bases	Base Size	1333	1344	2400 / 2405 / 3810	2600 / 2605	Veneer Upcharge	Polished Chrome Upcharge
36 x 72	2	22"	2,072	2,099	2,287	2,475	694	330
36 x 84	2	22"	2,135	2,166	2,487	2,724	811	330
36 x 96	2	22"	2,138	2,170	2,495	2,735	927	330
36 x 120	3	22"	3,049	3,089	3,501	3,803	1,157	495
36 x 144	3	22"	3,200	3,246	3,740	4,101	1,389	495
42 x 72	2	26"	2,675	2,719	3,149	3,475	811	397
42 x 84	2	26"	2,732	2,778	3,166	3,497	945	397
42 x 96	2	26"	2,786	2,836	3,175	3,509	1,080	397
42 x 120	3	26"	4,071	4,138	4,497	4,929	1,351	595
42 x 144	3	26"	4,329	4,409	4,859	5,381	1,621	595
48 x 72	2	26"	2,368	2,396	3,031	3,327	927	397
48 x 84	2	26"	2,786	2,836	3,194	3,530	1,080	397
48 x 96	2	26"	2,853	2,905	3,210	3,553	1,235	397
48 x 120	3	26"	4,148	4,221	4,578	5,031	1,544	595
48 x 144	3	26"	4,277	4,356	4,955	5,500	1,851	595

Note: 144" Ships in 2 pieces

J91CT BOATSHAPE



Table Size	Bases	Base Size	1333	1344	2400 / 2405 / 3810	2600 / 2605	Veneer Upcharge	Polished Chrome Upcharge
36 x 72	2	22"	2,099	2,129	2,352	2,557	694	330
36 x 84	2	22"	2,166	2,199	2,568	2,827	811	330
36 x 96	2	22"	2,170	2,202	2,577	2,838	927	330
36 x 120	3	22"	3,089	3,130	3,605	3,931	1,157	495
36 x 144	3	22"	3,246	3,295	3,865	4,257	1,389	495
42 x 72	2	26"	2,719	2,765	3,262	3,616	811	397
42 x 84	2	26"	2,778	2,827	3,281	3,640	945	397
42 x 96	2	26"	2,836	2,887	3,290	3,652	1,080	397
42 x 120	3	26"	4,138	4,211	4,646	5,116	1,351	595
42 x 144	3	26"	4,409	4,496	5,040	5,609	1,621	595
48 x 72	2	26"	2,396	2,424	3,132	3,455	927	397
48 x 84	2	26"	2,836	2,887	3,309	3,677	1,080	397
48 x 96	2	26"	2,905	2,960	3,329	3,700	1,235	397
48 x 120	3	26"	4,221	4,297	4,734	5,226	1,544	595
48 x 144	3	26"	4,356	4,439	5,142	5,739	1,851	595

Note: 144" Ships in 2 pieces

J11CT

MEETING AND CONFERENCE TABLES

- Grade 3 powdercoat, Grade 1 laminate standard
- Wood Edges and Veneer are Maple Species (veneer is long grain)
- Oak Edges and Veneer are available at the same price, specify on order
- Several optional power solutions available, see Power Solutions Section



J11CT ROUND



Wood Edges Only

Table Size	Bases	Base Size	1333	1344	2400 / 2405 / 3810	2600 / 2605	Veneer Upcharge	Polished Chrome Upcharge
42 Round	1	22"	842	857	1,316	1,511	473	227
48 Round	1	26"	957	977	1,504	1,729	617	257



J11CT SQUARE



Wood Edges Only

Table Size	Bases	Base Size	1333	1344	2400 / 2405 / 3810	2600 / 2605	Veneer Upcharge	Polished Chrome Upcharge
42 Square	1	22"	882	898	1,204	1,371	473	227
48 Square	1	26"	1,003	1,025	1,329	1,513	617	257

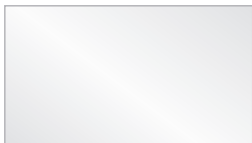

J11CT RECTANGULAR



Wood Edges Only

Table Size	Bases	Base Size	1333	1344	2400 / 2405 / 3810	2600 / 2605	Veneer Upcharge	Polished Chrome Upcharge
36 x 72	2	22"	1,587	1,614	1,791	1,970	694	455
36 x 84	2	22"	1,648	1,677	1,979	2,205	811	455
36 x 96	2	22"	1,651	1,679	1,986	2,215	927	455
36 x 120	3	22"	2,327	2,364	2,753	3,038	1,157	682
36 x 144	3	22"	2,468	2,513	2,981	3,324	1,389	682
42 x 72	2	26"	1,991	2,032	2,440	2,749	811	515
42 x 84	2	26"	2,045	2,089	2,455	2,769	945	515
42 x 96	2	26"	2,097	2,143	2,463	2,779	1,080	515
42 x 120	3	26"	3,040	3,104	3,442	3,854	1,351	772
42 x 144	3	26"	3,286	3,363	3,784	4,282	1,621	772
48 x 72	2	26"	1,699	1,724	2,325	2,607	927	515
48 x 84	2	26"	2,097	2,143	2,479	2,801	1,080	515
48 x 96	2	26"	2,158	2,209	2,497	2,822	1,235	515
48 x 120	3	26"	3,116	3,184	3,519	3,949	1,544	772
48 x 144	3	26"	3,238	3,311	3,876	4,396	1,851	772

Note: 144" Ships in 2 pieces

J11CT

MEETING AND CONFERENCE TABLES

- Grade 3 powdercoat, Grade 1 laminate standard
- Wood Edges and Veneer are Maple Species (veneer is long grain)
- Oak Edges and Veneer are available at the same price, specify on order
- Several optional power solutions available, see Power Solutions Section



J11CT RACETRACK



Wood Edges Only



Table Size	Bases	Base Size	1333	1344	2400 / 2405 / 3810	2600 / 2605	Veneer Upcharge	Polished Chrome Upcharge
36 x 72	2	22"	1,613	1,639	1,829	2,017	694	455
36 x 84	2	22"	1,675	1,708	2,026	2,265	811	455
36 x 96	2	22"	1,678	1,711	2,035	2,277	927	455
36 x 120	3	22"	2,362	2,402	2,813	3,114	1,157	682
36 x 144	3	22"	2,511	2,557	3,050	3,413	1,389	682
42 x 72	2	26"	2,030	2,074	2,503	2,829	811	515
42 x 84	2	26"	2,086	2,133	2,519	2,852	945	515
42 x 96	2	26"	2,141	2,190	2,530	2,863	1,080	515
42 x 120	3	26"	3,102	3,169	3,527	3,961	1,351	772
42 x 144	3	26"	3,358	3,440	3,890	4,412	1,621	772
48 x 72	2	26"	1,722	1,750	2,385	2,680	927	515
48 x 84	2	26"	2,141	2,190	2,547	2,884	1,080	515
48 x 96	2	26"	2,205	2,258	2,565	2,907	1,235	515
48 x 120	3	26"	3,180	3,252	3,608	4,062	1,544	772
48 x 144	3	26"	3,308	3,388	3,985	4,533	1,851	772

Note: 144" Ships in 2 pieces

J11CT BOATSHAPE



Wood Edges Only



Table Size	Bases	Base Size	1333	1344	2400 / 2405 / 3810	2600 / 2605	Veneer Upcharge	Polished Chrome Upcharge
36 x 72	2	22"	1,639	1,670	1,892	2,098	694	455
36 x 84	2	22"	1,708	1,740	2,108	2,368	811	455
36 x 96	2	22"	1,711	1,744	2,118	2,380	927	455
36 x 120	3	22"	2,402	2,443	2,916	3,243	1,157	682
36 x 144	3	22"	2,557	2,607	3,176	3,568	1,389	682
42 x 72	2	26"	2,074	2,119	2,617	2,971	811	515
42 x 84	2	26"	2,133	2,182	2,633	2,993	945	515
42 x 96	2	26"	2,190	2,242	2,645	3,006	1,080	515
42 x 120	3	26"	3,169	3,242	3,678	4,147	1,351	772
42 x 144	3	26"	3,440	3,526	4,071	4,640	1,621	772
48 x 72	2	26"	1,750	1,777	2,488	2,810	927	515
48 x 84	2	26"	2,190	2,242	2,664	3,031	1,080	515
48 x 96	2	26"	2,258	2,314	2,682	3,055	1,235	515
48 x 120	3	26"	3,252	3,329	3,766	4,257	1,544	772
48 x 144	3	26"	3,388	3,470	4,174	4,769	1,851	772

Note: 144" Ships in 2 pieces

24CT/24VT

MEETING AND CONFERENCE TABLES

- 24CT, Grade 3 powdercoat, Grade 1 laminate standard
- 24VT, Long Grain Maple Veneer, standard wood finish
- Optional Oak Species Edges and Veneer, available same price, order must specify
- Several optional power solutions available, see Power Solutions section



24CT/24VT ROUND



Table Size	Bases	Base Size	24CT 1300	24CT 1344	24CT 2400 / 2405	24CT 2600 / 2605	24VT Veneer Upcharge	Polished Chrome Upcharge
36 Round	1	22	679	760	1,528	1,713	347	98
42 Round	1	28	832	909	1,756	1,986	473	116
48 Round	1	36	1,031	1,106	2,028	2,243	617	142
54 Round	1	5-36	1,249	1,336	2,519	2,873	781	282
60 Round	1	5-36	1,293	1,391	2,554	2,908	965	282

5-36 = 5 column 36" X base

24CT/24VT SQUARE



Table Size	Bases	Base Size	24CT 1300	24CT 1344	24CT 2400 / 2405	24CT 2600 / 2605	24VT Veneer Upcharge	Polished Chrome Upcharge
36 Square	1	28	677	748	1,162	1,429	347	116
42 Square	1	36	983	1,055	1,533	1,754	473	142
48 Square	1	5-36	1,001	1,081	1,670	1,943	617	282
54 Square	1	5-36	1,720	1,817	2,513	2,805	781	282
60 Square	1	5-36	1,768	1,867	2,547	2,841	965	282

5-36 = 5 column 36" X base

24CT/24VT RECTANGULAR

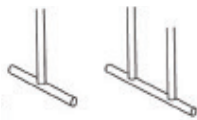

Tables 36" wide include single column end bases. Tables wider than 36" include double column end bases.

Tables 144" or longer ship in two pieces.

Table Size	Bases	Base Size	24CT 1300	24CT 1344	24CT 2400 / 2405	24CT 2600 / 2605	24VT Veneer Upcharge	Polished Chrome Upcharge
36 x 60	2	22	887	962	1,636	1,909	482	135
36 x 72	2	22	1,052	1,103	1,652	1,934	694	135
36 x 84	2	22	1,234	1,370	2,017	2,329	811	135
36 x 96	2	22	1,239	1,379	2,035	2,335	927	135
42 x 72	2	32	1,704	1,804	2,735	3,047	811	317
42 x 84	2	32	1,818	1,932	2,773	3,084	945	317
42 x 96	2	32	1,932	2,066	2,791	3,102	1,080	317
42 x 108	2	32	2,050	2,198	2,827	3,174	1,215	317
42 x 120	3	32	2,670	2,834	3,584	3,916	1,351	476
48 x 84	2	32	1,932	2,066	2,827	3,138	1,080	317
48 x 96	2	32	2,066	2,216	2,864	3,174	1,235	317
48 x 108	3	32	2,706	2,873	3,598	3,938	1,389	476
48 x 120	3	32	2,834	3,026	3,745	4,083	1,544	476
48 x 144	3	32	3,099	3,324	4,539	4,533	1,851	476
60 x 120	3	32	3,622	3,872	4,310	4,658	1,929	476
60 x 144	3	32	4,060	4,346	5,060	5,248	2,314	476
60 x 168	3	32	4,848	5,219	5,927	6,804	2,701	476
60 x 192	4	32	5,718	6,149	6,766	7,499	3,086	634

24CT/24VT

MEETING AND CONFERENCE TABLES

- 24CT, Grade 3 powdercoat, Grade 1 laminate standard
- 24VT, Long Grain Maple Veneer, standard wood finish
- Optional Oak Species Edges and Veneer, available same price, order must specify
- Several optional power solutions available, see Power Solutions section



24CT/24VT
RACETRACK



Wood Edges Only



Table Size	Bases	Base Size	24CT 1300	24CT 1344	24CT 2400 / 2405	24CT 2600 / 2605	24VT Veneer Upcharge	Polished Chrome Upcharge
36 x 60	2	22	929	1,012	2,017	2,400	482	135
36 x 72	2	22	1,012	1,109	2,046	2,419	694	135
36 x 84	2	22	1,173	1,460	2,532	2,932	811	135
36 x 96	2	22	1,316	1,469	2,557	2,949	927	135
42 x 72	2	32	1,772	1,882	3,313	3,677	811	317
42 x 84	2	32	1,898	2,024	3,356	3,771	945	317
42 x 96	2	32	2,024	2,172	3,366	3,798	1,080	317
42 x 108	2	32	2,155	2,319	3,431	3,878	1,215	317
42 x 120	3	32	2,784	2,967	4,257	4,714	1,351	476
48 x 84	2	32	2,024	2,172	3,431	3,840	1,080	317
48 x 96	2	32	2,172	2,338	3,474	3,878	1,235	317
48 x 108	3	32	2,823	3,010	4,294	4,741	1,389	476
48 x 120	3	32	2,967	3,179	4,476	4,961	1,544	476
48 x 144	3	32	3,257	3,507	5,415	5,889	1,851	476
60 x 120	3	32	3,851	4,110	5,232	5,699	1,929	476
60 x 144	3	32	4,314	4,628	6,301	6,887	2,314	476
60 x 168	3	32	5,183	5,589	7,399	8,567	2,701	476
60 x 192	4	32	6,094	6,566	8,340	9,342	3,086	634

Tables 36" wide include single column end bases. Tables wider than 36" include double column end bases. Tables 144" or longer ship in two pieces.

24CT/24VT
BOATSHAPE



Wood Edges Only



Table Size	Bases	Base Size	24CT 1300	24CT 1344	24CT 2400 / 2405	24CT 2600 / 2605	24VT Veneer Upcharge	Polished Chrome Upcharge
33 x 42 x 96	2	32	1,883	2,082	3,562	4,063	1,080	317
36 x 48 x 120	3	32	2,821	3,035	4,709	5,229	1,544	476
36 x 48 x 144	3	32	3,122	3,383	5,795	6,336	1,851	476
48 x 60 x 144	3	32	4,437	4,767	7,023	7,689	2,314	476
48 x 60 x 168	3	32	5,347	5,777	8,366	9,553	2,701	476
48 x 60 x 192	4	32	6,280	6,776	9,295	10,456	3,086	634

Tables include double column end bases. Tables 144" or longer ship in two pieces.

31CT/31VT

MEETING AND CONFERENCE TABLES

- 31CT, Grade 1 Laminate Standard Wood Finish
- 31VT, Long Grain Maple Veneer, Standard Wood Finish
- Optional Oak Edges and Long Grain Veneer, same price, order must specify
- Several optional power solutions available, see Power Solutions section

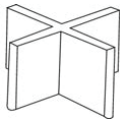

31CT/31VT ROUND



Table Size	Bases	31CT 1300	31CT 1344	31CT 2400 / 2405	31VT 2400 / 2405	31CT 2600 / 2605	31VT 2600 / 2605
36 Round	1	3,306	3,380	4,191	7,157	4,383	7,573
42 Round	1	3,462	3,542	4,430	7,404	4,672	8,135
48 Round	1	3,501	3,582	4,548	8,155	4,773	8,596
54 Round	1	3,733	3,824	5,064	10,083	5,438	10,341
60 Round	1	3,776	3,882	5,100	10,432	5,475	10,699

Panel Base

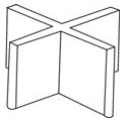

31CT/31VT SQUARE



Table Size	Bases	31CT 1300	31CT 1344	31CT 2400 / 2405	31VT 2400 / 2405	31CT 2600 / 2605	31VT 2600 / 2605
36 Square	1	3,304	3,377	3,809	6,059	4,088	6,309
42 Square	1	3,455	3,527	4,075	6,687	4,306	6,940
48 Square	1	3,474	3,555	4,173	6,953	4,461	7,856
54 Square	1	3,730	3,826	4,557	9,298	4,862	9,775
60 Square	1	3,775	3,881	4,592	9,604	4,898	10,105

Panel Base

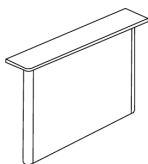

31CT/31VT RECTANGULAR



Table Size	Bases	31CT 1300	31CT 1344	31CT 2400 / 2405	31VT 2400 / 2405	31CT 2600 / 2605	31VT 2600 / 2605
36 x 60	2	2,119	2,197	2,898	6,716	3,186	6,943
36 x 72	2	2,197	2,291	2,920	7,001	3,217	7,218
36 x 84	2	2,484	2,484	3,304	7,278	3,629	7,493
36 x 96	2	2,489	2,489	3,320	7,882	3,636	8,060
42 x 72	2	2,410	2,515	3,496	7,324	3,819	7,624
42 x 84	2	2,528	2,651	3,530	7,882	3,857	8,060
42 x 96	2	2,651	2,791	3,551	8,189	3,878	8,405
42 x 108	2	2,774	2,927	3,591	8,745	3,953	8,970
42 x 120	3	3,720	3,891	4,675	10,981	5,026	11,233
48 x 84	2	2,651	2,791	3,591	8,070	3,914	8,320
48 x 96	2	2,791	2,947	3,626	8,769	3,953	8,985
48 x 108	2	2,927	3,105	3,866	9,212	4,218	9,428
48 x 120	3	3,891	4,090	4,847	11,650	5,199	11,919
48 x 144	3	4,169	4,403	5,677	13,444	5,669	13,748
60 x 120	3	4,732	4,980	5,439	14,950	5,803	15,547
60 x 144	3	5,174	5,475	6,224	16,463	6,425	16,850
60 x 168	3	6,017	6,407	7,147	17,924	8,069	18,408
60 x 192	4	6,464	6,911	8,402	22,855	9,169	23,415

- Panel Base
- Tables 144" or longer ship in two pieces.

31CT/31VT

MEETING AND CONFERENCE TABLES

- 31CT, Grade 1 Laminate Standard Wood Finish
- 31VT, Long Grain Maple Veneer, Standard Wood Finish
- Optional Oak Edges and Long Grain Veneer, same price, order must specify
- Several optional power solutions available, see Power Solutions section

31CT/31VT RACETRACK



Table Size	Bases	31CT 1300	31CT 1344	31CT 2400 / 2405	31VT 2400 / 2405	31CT 2600 / 2605	31VT 2600 / 2605
36 x 60	2	2,161	2,252	3,304	7,681	3,702	8,399
36 x 72	2	2,252	2,350	3,331	8,081	3,724	8,643
36 x 84	2	2,560	2,560	3,838	8,810	4,258	9,113
36 x 96	2	2,570	2,570	3,866	9,233	4,276	9,403
42 x 72	2	2,486	2,598	4,097	8,810	4,483	9,113
42 x 84	2	2,616	2,751	4,142	9,233	4,576	9,406
42 x 96	2	2,751	2,900	4,152	9,686	4,603	9,888
42 x 108	2	2,882	3,053	4,218	10,197	4,689	10,381
42 x 120	3	3,840	4,029	5,380	12,419	5,861	12,819
48 x 84	2	2,751	2,900	4,218	9,775	4,651	9,595
48 x 96	2	2,900	3,073	4,271	10,275	4,689	10,583
48 x 108	2	3,053	3,248	4,592	11,606	5,064	11,082
48 x 120	3	4,029	4,250	5,611	13,444	6,091	13,737
48 x 144	3	4,335	4,592	6,595	15,143	7,093	15,695
60 x 120	3	4,954	5,226	6,405	16,511	7,082	16,944
60 x 144	3	5,441	5,770	7,525	18,512	8,139	21,228
60 x 168	3	6,368	6,796	8,604	20,159	9,918	23,292
60 x 192	4	6,855	7,352	10,050	25,255	11,101	27,124

- Panel Base
- Tables 144" or longer ship in two pieces.

31CT/31VT BOATSHAPE



Table Size	Bases	31CT 1300	31CT 1344	31CT 2400 / 2405	31VT 2400 / 2405	31CT 2600 / 2605	31VT 2600 / 2605
33 x 42 x 96	2	2,795	2,957	4,506	9,991	5,033	10,204
36 x 48 x 120	3	3,274	3,503	6,079	13,843	6,625	14,152
36 x 48 x 144	3	3,592	3,865	7,218	15,633	7780	16,210
48 x 60 x 144	3	4,750	5,090	8,281	19,154	8,981	22,007
48 x 60 x 168	3	6,540	6,989	9,704	20,884	10,948	24,178
48 x 60 x 192	4	7,052	7,569	11,055	26,061	12,268	28,028

- Panel Base
- Tables 144" or longer ship in two pieces.

51CT/51VT

MEETING AND CONFERENCE TABLES

- 51CT, Grade 1 Laminate Standard Wood Finish
- 51VT, Long Grain Maple Veneer, Standard Wood Finish
- Optional Oak Edges and Long Grain Veneer, same price, order must specify
- Several optional power solutions available, see Power Solutions section

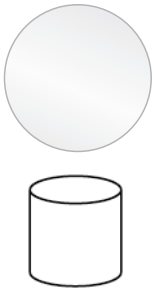

51CT/51VT ROUND



Table Size	Bases	51CT 1300	51CT 1344	51CT 2400 / 2405	51VT 2400 / 2405	51CT 2600 / 2605	51VT 2600 / 2605
36 Round	1	1,256	1,334	2,141	4,766	2,335	5,180
42 Round	1	1,628	1,704	2,594	5,226	2,833	5,954
48 Round	1	1,665	1,744	2,706	5,976	2,940	6,420
54 Round	1	2,278	2,369	3,609	8,381	3,982	8,636
60 Round	1	2,324	2,425	3,647	8,728	4,019	8,996

Drum Base



51CT/51VT SQUARE



Table Size	Bases	51CT 1300	51CT 1344	51CT 2400 / 2405	51VT 2400 / 2405	51CT 2600 / 2605	51VT 2600 / 2605
36 Square	1	1,254	1,327	1,761	3,668	2,040	3,916
42 Square	1	1,616	1,691	2,239	4,509	2,468	4,761
48 Square	1	1,635	1,719	2,335	4,772	2,622	5,675
54 Square	1	2,274	2,371	3,101	7,591	3,408	8,072
60 Square	1	2,321	2,424	3,138	7,899	3,444	8,401

Drum Base

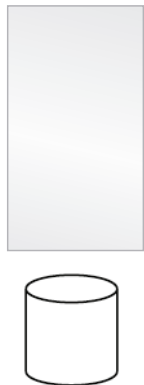

51CT/51VT RECTANGULAR



Table Size	Bases	51CT 1300	51CT 1344	51CT 2400 / 2405	51VT 2400 / 2405	51CT 2600 / 2605	51VT 2600 / 2605
36 x 60	2	2,462	2,543	3,245	4,797	3,539	5,592
36 x 72	2	2,543	2,636	3,262	5,651	3,559	5,870
36 x 84	2	2,827	2,827	3,647	5,930	3,975	6,145
36 x 96	2	2,833	2,833	3,667	6,532	3,982	6,711
42 x 72	2	3,026	3,129	4,106	6,404	4,430	6,701
42 x 84	2	3,144	3,262	4,142	6,962	4,468	7,142
42 x 96	2	3,262	3,401	4,167	7,266	4,488	7,489
42 x 108	2	3,384	3,542	4,199	7,826	4,562	8,053
42 x 120	2	3,509	3,679	4,461	8,295	4,812	8,543
48 x 84	2	3,418	3,555	4,355	8,295	4,444	7,402
48 x 96	2	3,555	3,712	4,391	7,847	4,717	8,066
48 x 108	2	3,695	3,871	4,633	8,295	4,985	8,508
48 x 120	2	3,828	4,031	4,788	8,966	5,138	9,232
48 x 144	2	4,108	4,343	5,620	10,754	5,610	11,062
60 x 120	2	5,439	5,686	6,145	12,983	6,506	13,578
60 x 144	2	5,879	6,179	6,928	14,494	7,130	14,882
60 x 168	2	6,707	7,098	7,838	17,736	8,758	16,778
60 x 192	3	8,759	9,207	9,858	19,293	10,621	19,855

- 5100 Series Drum Base
- Tables 144" or longer ship in two pieces.

MEETING AND CONFERENCE TABLES

- 51CT, Grade 1 Laminate Standard Wood Finish
- 51VT, Long Grain Maple Veneer, Standard Wood Finish
- Optional Oak Edges and Long Grain Veneer, same price, order must specify
- Several optional power solutions available, see Power Solutions section

51CT/51VT RACETRACK



Table Size	Bases	51CT 1300	51CT 1344	51CT 2400 / 2405	51VT 2400 / 2405	51CT 2600 / 2605	51VT 2600 / 2605
36 x 60	2	2,506	2,594	3,647	6,333	4,047	7,050
36 x 72	2	2,594	2,697	3,675	6,737	4,068	7,297
36 x 84	2	2,906	2,906	4,185	7,460	4,603	7,764
36 x 96	2	2,914	2,914	4,211	7,884	4,622	8,057
42 x 72	2	3,092	3,209	4,708	7,888	5,090	8,193
42 x 84	2	3,228	3,360	4,758	8,314	5,187	8,486
42 x 96	2	3,360	3,516	4,767	8,769	5,217	8,970
42 x 108	2	3,497	3,667	4,834	9,274	5,301	9,464
42 x 120	2	3,626	3,818	5,168	9,733	5,647	10,133
48 x 84	2	3,516	3,668	4,985	8,857	5,417	8,679
48 x 96	2	3,668	3,839	5,033	9,358	5,454	9,664
48 x 108	2	3,819	4,015	5,361	10,688	5,827	10,162
48 x 120	2	3,970	4,190	5,548	10,754	6,030	11,050
48 x 144	2	4,274	4,535	6,535	12,456	7,035	13,006
60 x 120	2	5,658	5,932	7,110	14,539	7,595	14,971
60 x 144	2	6,147	6,476	8,230	16,539	8,843	19,220
60 x 168	2	7,056	7,487	9,381	19,972	10,605	23,101
60 x 192	3	9,150	9,647	11,502	21,694	12,556	23,562

- 5100 Series Drum Base
- Tables 144" or longer ship in two pieces.

51CT/51VT BOATSHAPE



Table Size	Bases	51CT 1300	51CT 1344	51CT 2400 / 2405	51VT 2400 / 2405	51CT 2600 / 2605	51VT 2600 / 2605
33 x 42 x 96	2	3,410	3,569	5,123	9,072	5,647	9,283
36 x 48 x 120	2	4,039	4,271	6,018	11,158	6,566	11,471
36 x 48 x 144	2	4,359	4,628	7,158	12,943	7,721	13,523
48 x 60 x 144	2	6,280	6,566	8,929	17,187	9,628	20,002
48 x 60 x 168	2	7,231	7,624	10,335	20,695	11,577	23,986
48 x 60 x 192	3	9,349	9,867	12,509	22,507	13,724	24,469

- 5100 Series Drum Base
- Tables 144" or longer ship in two pieces.

MEETING AND CONFERENCE TABLES

- Grade 3 Powdercoat, Grade 1 Laminate, Standard Wood Finish
- Wood Edges and Veneer are Maple Species (veneer is long grain)
- Oak Edges and Veneer are available at the same price, specify on order
- Several optional power solutions available, see Power Solutions Section

ST3X ROUND PEDESTAL BASE



Table Size	Bases	Base Size	1300 / 1333 1340 / 1440	1444 / 2323	2405 / 2420	2344	4150	Veneer Upcharge	Polished Chrome Upcharge	Welded Base Upcharge
30 Round	1	26S	670	816	1,336	949	N/A	242	109	48
36 Round	1	26S	715	891	1,428	1,020	N/A	347	109	48
42 Round	1	32S-3	899	1,118	1,656	1,255	N/A	473	109	48
48 Round	1	32S-3	918	1,158	1,713	1,293	2,110	617	109	48
54 Round	1	38Q	1,324	1,636	2,522	1,770	N/A	781	163	N/A
60 Round	1	38Q	1,338	1,676	2,553	1,811	2,975	965	163	N/A

• ST3X- Pedestal Base

ST3X SQUARE PEDESTAL BASE

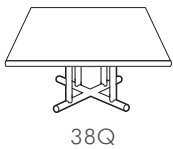

Table Size A x B	Bases	Base Size	1300 / 1333 1340 / 1440	1444 / 2323	2405 / 2420	2344	Veneer Upcharge	Polished Chrome Upcharge	Welded Base Upcharge
30 x 30	1	26S	644	755	1,010	891	242	109	48
36 x 36	1	32S-3	735	852	1,141	986	347	109	48
42 x 42	1	32S-3	859	1,027	1,374	1,158	473	109	48
48 x 48	1	38Q	1,078	1,259	1,659	1,391	617	163	N/A
54 x 54	1	38Q	1,302	1,636	2,005	1,770	781	163	N/A
60 x 60	1	38Q	1,364	1,676	2,163	1,811	965	163	N/A

• ST3X- Pedestal Base

ST3X RECTANGULAR PEDESTAL BASE

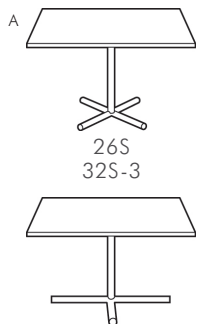
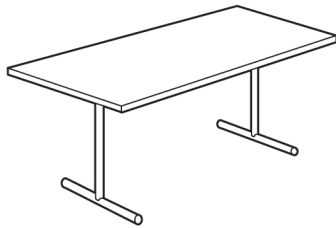

Table Size A x B x C	Bases	Base Size	1300 / 1333 1340 / 1440	1444 / 2323	2405 / 2420	2344	Veneer Upcharge	Polished Chrome Upcharge	Welded Base Upcharge
24 x 30	1	26S	614	721	954	853	194	109	48
24 x 36	1	26S	644	750	1,010	882	231	109	48
30 x 36	1	32S-3	692	814	1,088	948	290	109	48
30 x 48	1	38M-3	777	908	1,216	1,043	385	163	48
36 x 48	1	38M-3	836	995	1,308	1,130	463	163	48

• ST3X- Pedestal Base

MEETING AND CONFERENCE TABLES

- Grade 3 Powdercoat Grade 1 Laminate Standard Wood Finish
- Wood Edges and Veneer are Maple Species (veneer is long grain)
- Oak Edges and Veneer are available at the same price, specify on order
- Several optional power solutions available, see Power Solutions Section



ST3T / ST3C
RECTANGULAR



Table Size A x B	Bases	Base Size	1300 / 1333 1340 / 1440	1444 / 2323	2405 / 2420	2344	4720	4150	Veneer Upcharge	Polished Chrome Upcharge	Welded Base Upcharge
18 x 48	1	14T or C	667	742	1,029	874	796	1,134	231	109	48
18 x 60	1	14T or C	687	827	1,134	960	871	1,225	290	109	48
18 x 72	1	14T or C	726	874	1,220	1,008	953	1,376	347	109	48
18 x 90	1	14T or C	1,042	1,248	1,841	1,380	1,369	N/A	434	109	48
24 x 48	1	18T or C	679	826	1,125	960	809	1,147	309	109	48
24 x 60	1	18T or C	733	912	1,260	1,047	917	1,238	385	109	48
24 x 72	1	18T or C	806	986	1,372	1,118	1,034	1,389	463	109	48
24 x 90	1	18T or C	1,133	1,361	1,921	1,494	1,460	N/A	579	109	48
30 x 48	1	24T	728	863	1,169	996	886	1,330	385	109	48
30 x 60	1	24T	816	989	1,356	1,121	1,021	1,456	482	109	48
30 x 72	1	24T	869	1,055	1,468	1,190	1,113	1,664	579	109	48
30 x 90	1	24T	1,294	1,413	1,997	1,549	1,664	N/A	724	109	48
36 x 48	1	24T	789	950	1,263	1,084	968	1,411	463	109	48
36 x 60	1	24T	855	1,044	1,497	1,174	1,103	1,664	579	109	48
36 x 72	1	24T	923	1,090	1,609	1,223	1,217	1,845	694	109	48
36 x 90	1	24T	1,364	1,595	2,108	1,728	1,825	N/A	868	109	48
42 x 84	1	32TT	1,590	1,663	2,322	1,797	2,204	N/A	945	163	48
42 x 96	1	32TT	1,600	1,705	2,475	1,836	2,214	N/A	1,080	163	48
48 x 96	1	38TT	1,644	1,761	2,518	1,891	N/A	N/A	1,235	163	48
48 x 120	3	38TT	2,059	2,220	3,061	2,353	N/A	N/A	1,544	216	48
48 x 144*	3	38TT	2,213	2,415	3,334	2,547	N/A	N/A	1,851	216	48
60 x 120	3	38TT	2,228	2,415	3,281	2,547	N/A	N/A	1,929	216	48
60 x 144*	3	38TT	2,408	2,638	3,579	2,773	N/A	N/A	2,314	216	48

- Tables 144" or longer ship in two pieces
- ST3T- Symmetrical end base, one column
- ST3C- Cantilever end base, one column
- T = one column end base
- TT = two column end base
- First two numbers of base style represents base dimension

Small Order Charge: Orders with a combined Net price under \$1,000 will be subject to a Special Handling Charge of \$125 Net. One charge per order.

TABLE TOP EDGE PROFILES

SYNTECH™

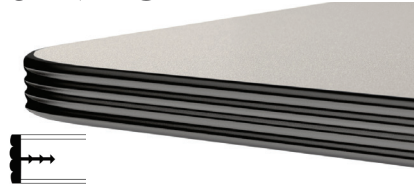

13500 1.25" fluted vinyl edge. High pressure laminate top standard with 3" radius corners. Available in a variety of colors



23000 1.25" x .25" wood banded edge high pressure laminate or veneer top surface



24055 1.25" x 1.25" full bullnose wood edge high pressure laminate, veneer, or Veneer Art top surface



13333 1.25" solid vinyl flat T mold edge. High pressure laminate top standard with 1" radius corners. Available in a variety of colors



24000 1.25" x 1.25" square wood edge high pressure laminate, veneer, or Veneer Art top surface



38350 1.25" x 2" beveled wood edge with high pressure laminate, veneer, or Veneer Art top surface.



1440 1.25 flat PVC edge band. High pressure laminate. Radius corners not available



24022 1.25" x 1.25" half bullnose wood edge high pressure laminate, veneer, or Veneer Art top surface

CURV™

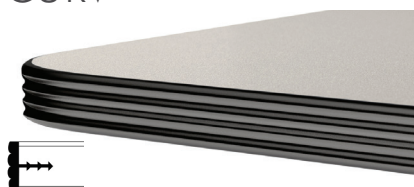

13500 1.25" fluted vinyl edge. High pressure laminate top standard with 3" radius corners. Available in a variety of colors



24000 1.25" x 1.25" square wood edge high pressure laminate, veneer, or Veneer Art top surface



15300 1.25" 21-ply plywood reverse knife edge high pressure laminate top surface



13333 1.25" solid vinyl flat T mold edge. High pressure laminate top standard with 1" radius corners. Available in a variety of colors



24055 1.25" x 1.25" full bullnose wood edge high pressure laminate, veneer, or Veneer Art top surface



1440 1.25 flat PVC edge band. High pressure laminate. Radius corners not available



38350 1.25" x 2" beveled wood edge with high pressure laminate, veneer, or Veneer Art top surface.

TABLE TOP EDGE PROFILES

CONFERENCE TABLES

Small Order Charge: Orders with a combined Net price under \$1,000 will be subject to a Special Handling Charge of \$125 Net. One charge per order.



1333
1-1/4" laminate top. The edges are banded with solid vinyl "T" molding, with 1" radius at corners.



1344
1.25" solid vinyl flat T mold edge. High pressure laminate top standard with 1" radius corners. Available in a variety of colors



2400
1.25" x 1.25" square wood edge high pressure laminate, veneer, or Veneer Art top surface



2405
1-1/4" laminate top. The edges are banded with hardwood. No radius at corners.



3810
1.25" x 1.25" beveled wood edge high pressure laminate, veneer, or Veneer Art top surface



2600
1.75" x 2" squared wood edge high pressure laminate, veneer, or Veneer Art top surface



2605
1.75" X 2" full bullnose wood edge high pressure laminate, veneer, or Veneer Art top surface

STORM™



4720 Postformed
1-1/4" plastic laminate top. The front edge is sloped, reducing strain on the wrist. The side and rear edge are banded with rigid PVC molding. Modesty edge 1440



1300 / 1307 Bumper T-Mold
1-1/4" laminate top. The edges are banded with solid vinyl "T" molding, with 7/8" radius at corners. Modesty edge 1300



1333 / 1337 Eased T-Mold
1-1/4" laminate top. The edges are banded with solid vinyl "T" molding, with 1" radius at corners. Modesty edge 1300



4150 / 4157 Sloped Urethane
1-1/4" laminate top. The front urethane edge is sloped, reducing strain on the wrist. The sides and rear have a flat urethane edge. Modesty edge 1440



1340 / 1347 Reveal T-Mold
1-1/4" laminate top. The edges are banded with 5/16" solid vinyl "T" molding, with 7/8" radius at corners. Modesty edge 1300

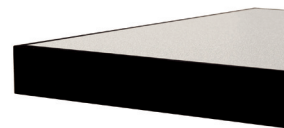

1440 / 1447 Flat PVC
1-1/4" laminate top. The edges are banded with flat PVC molding. No radius at corners. Modesty edge 1440

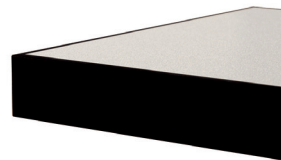

1444 / 1448 Flat PVC
1-3/4" laminate top. The edges are banded with flat PVC molding. No radius at corners. Modesty edge 1440



2405 / 2407 Wood Bullnose
1-1/4" laminate top. The edges are banded with hardwood. No radius at corners. Modesty edge Flat Wood Band



2323 / 2327 Wood Band
1-1/4" laminate top. The edges are banded with 1/4" hardwood. No radius at corners. Modesty edge Flat Wood Band



2344 / 2348 Wood Band
1-3/4" laminate top. The edges are banded with 1/4" hardwood. No radius at corners. Modesty edge Flat Wood Band



2420 / 2427 Wood Edge
1-1/4" laminate top. The edges are banded with hardwood. No radius at corners. Modesty edge Flat Wood Band

FALCON™

POWER SOLUTIONS

WORKBOOK/PRICE LIST August 2015

DELIVERED TO ZONE 1, ADD + 4% DELIVERED TO ZONE 2



Interlink IQ Starter Unit

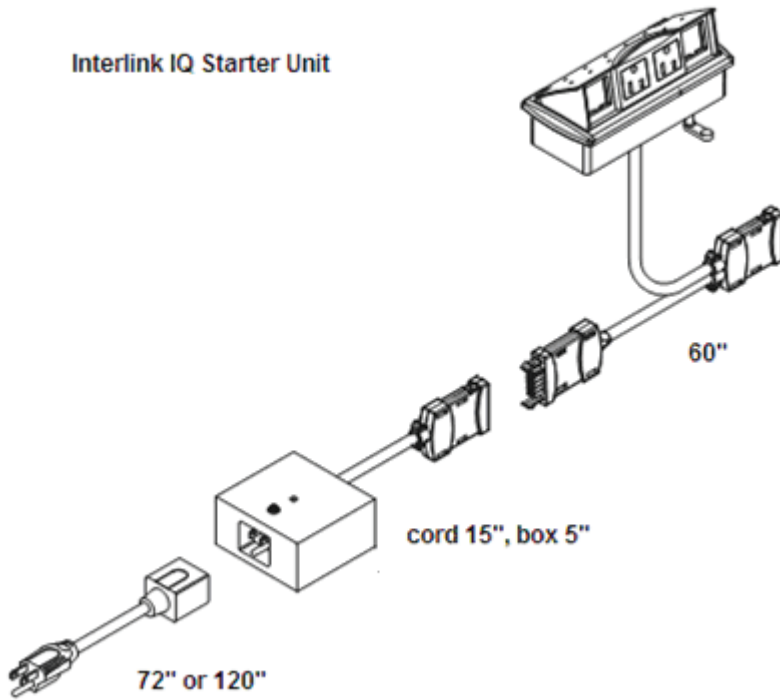

Interlink IQ Add on Unit

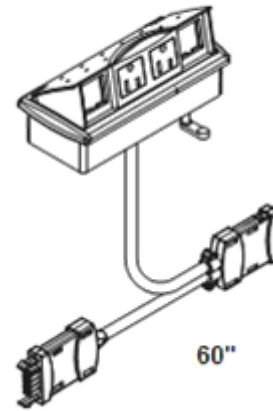

NON SEQUENTIAL POWER SYSTEM – 15 AMP SYSTEM RATING

The Non Sequential Power System is designed for use with most Falcon tables in training/classrooms where tables are reconfigured on a regular basis. This unit provides 15 amps of power in a flexible format. A single run can accommodate up to eight tables (60" long or less) with one miniport per table, or four tables with two miniports per table. Tables 72" or longer require two units per table. Additional table top access units available, contact your local sale representative or customer service for information.

- Up to 8 duplex non sequential devices
- Single Circuit Power
- 12 Amp System Rating
- 15 Amp Power Cord with 15 Amp over-current protection
- 40 Ft. Maximum Total Length
- Color: Black
- UL recognized

MIPT9IQ STARTER UNIT

Size	Price
72"	455
120"	477

MIPT9IQ ADD ON UNIT

Size	Price
60" only	175

Starter Link / Link #1

Add-On Link / Link #2 thru #8

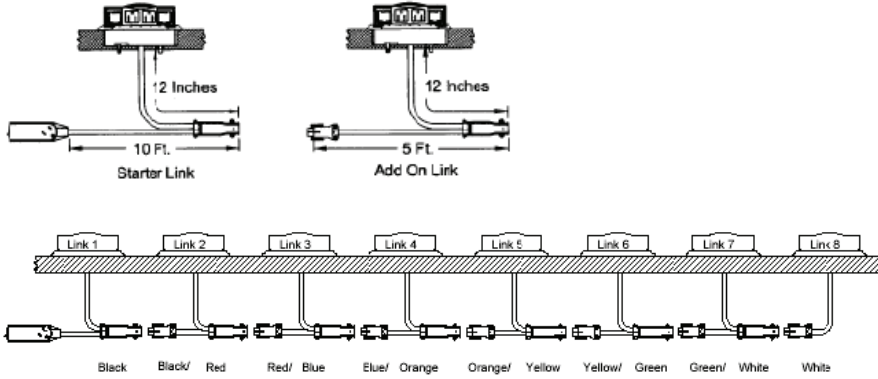

INTERLINK MINIPORT – 15 AMP SYSTEM RATING

This system is used for basic work surface power needs, connecting table to table without the need of an electrician. It can be used on most Falcon connected tables that require affordable power from a single power source. Not appropriate for Syntech tables.

- Up to 8 duplex devices and must be connected in sequence
- Single Circuit Power
- 12 Amp System Rating
- 15 Amp Power Cord with 15 Amp over-current protection
- 40 Ft. Maximum Total Length
- Color: Black
- UL Recognized

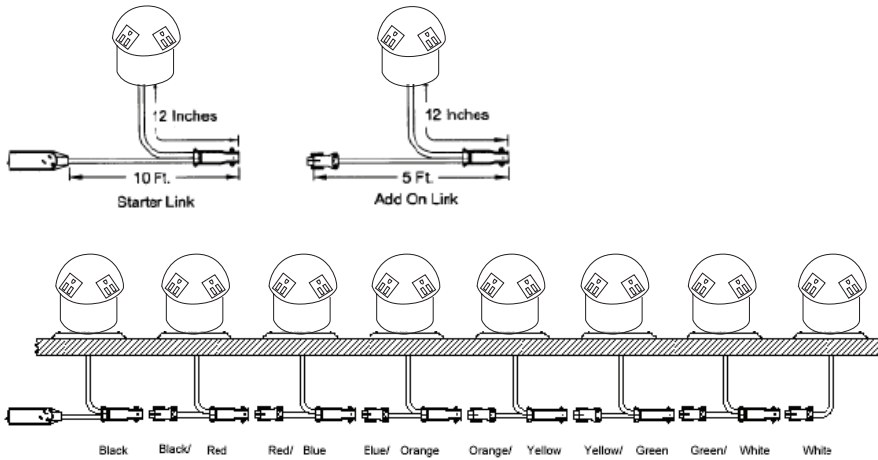

INTERLINK POWER SPHERE – 15 AMP SYSTEM RATING

This system is used for basic work surface power needs, connecting table to table without the need of an electrician. It can be used on most Falcon connected tables that require affordable power from a single power source. Not appropriate for Syntech tables.

Power/Communication Sphere (2) Simplex ~ (2) Data Ports

- Up to 8 duplex devices and must be connected in sequence
- Single Circuit Power
- 12 Amp System Rating
- 15 Amp Power Cord with 15 Amp over-current protection
- 40 Ft. Maximum Total Length
- Color: Black
- UL Recognized

Note: A single run can accommodate up to eight tables (60" long or less) with one miniport per table, or four tables with two miniports or power spheres per table. Tables 72" or longer require two units per table.

MIPT6

Starter Link	Connects to	Price
Link 1	Power Source	274
Link 2	Link 1	234
Link 3	Link 2	234
Link 4	Link 3	234
Link 5	Link 4	234
Link 6	Link 5	234
Link 7	Link 6	234
Link 8	Link 7	234

PS6

Starter Link	Connects to	Price
Link 1	Power Source	274
Link 2	Link 1	234
Link 3	Link 2	234
Link 4	Link 3	234
Link 5	Link 4	234
Link 6	Link 5	234
Link 7	Link 6	234
Link 8	Link 7	234

INTERCONNECT – (4) 20 AMP CIRCUIT POWER SYSTEM

Used for hard-wire power needs to connect table in longer, more permanent situations where an isolated circuit is needed. Can be used on any MATS shared leg table application. All power is accessible at the work surface and all cabling/ jumpers are clipped to underside of work surface. Licensed electrician is needed to connect to power source.

Interconnect System

- 8 wire, 4 circuit system
- 20 amp per circuit
- Up to 13 units per circuit
- UL / CUL listed Manufactured Wiring System (UL 183)

IPT6S Starter Kit Includes:

- (2) Interports / BE08977-3-X-S-F04-16
- (1) Power Infeed / BE08180-3-MTLC-72
- (1) H Block / BE08299-3 (bottom row, left)
- (1) H Block Mounting Kit / BE01500 (bottom row, center)
- (3) Conduit clamps / BE01501 (bottom row, right)

IPT6DA Double Add On Kit Includes:

- (2) Interports / BE08977-3-X-S-F04-16
- (1) M/M Adjustable Jumper / BE08116-3-60
- (1) H Block / BE08299-3 (bottom row, left)
- (1) H Block Mounting Kit / BE01500 (bottom row, center)
- (4) Conduit clamp / BE01501 (bottom row, right)

IPT6SA Single Add On Kit Includes:

- (1) Interport / BE08977-3-X-S-F04-46
- (1) Conduit clamp / BE01501

IPT6

Model #	Description	Price
IPT6S	Starter Kit	502
IPT6DA	Double Add On Kit	475
IPT6SA	Single Add On Kit	196

IPT6S

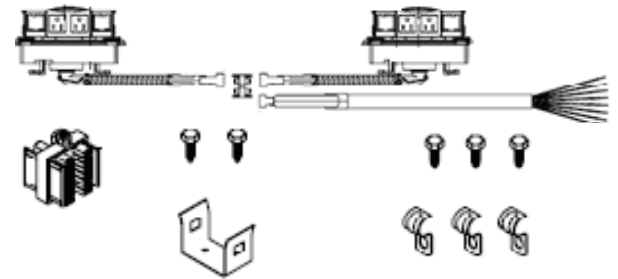

IPT6DA

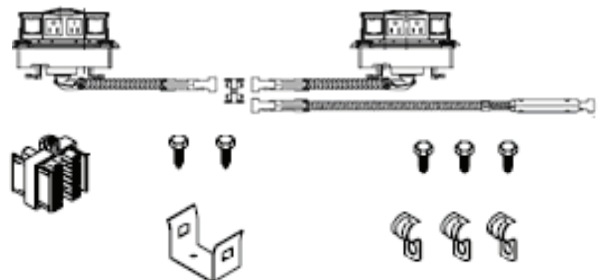

IPT6SA



X = circuit designation for Miniports. One Circuit (1, 2, 3, or 4) specified per unit. Circuit Designation does not change pricing

4-TRAC – (2) 20 AMP CIRCUIT POWER SYSTEM

Used for hard-wire power, to connect tables in longer, more permanent situations where an isolated circuit is not needed. Can be used on any Falcon MATS, Storm, or Syntech table application and all power is to be mounted to underside of work surface. Power is accessible, for plug in only, on underside of table and is accessed through grommets in the work surface or simply waterfall over edge to plug in. Licensed electrician is needed to connect power to the source.

- 4-Wires, 2 circuits, 20 Amps each (Circuit 1 and 2 only)
- 13 - Duplex receptacles per circuit, 26 duplex receptacles per power infeed maximum
- UL Listed as a Manufactured Wiring System

4-Trac Hard-wire Power Entry

- Includes (2) PVC Legway Wire Sleeves
- Must Specify Length
- Hard-wiring must be performed by a licensed electrician
- Plug in power entry SPEP1 simplifies system to single circuit



PD4 / PEH4

Model #	Description	Price
PD4-42	4-Trac 42" Table Kit	157
PD4-48	4-Trac 48" Table Kit	160
PD4-60	4-Trac 60" Table Kit	168
PD4-72	4-Trac 72" Table Kit	176
PEH4-1	4-Trac Hard-wire Power Entry	112

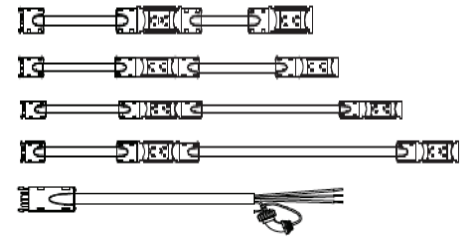

SYNTECH

Model #	Description	Kit Includes	Price
SEP42	42" table - Select Circuit 1 or Circuit 2	1 PD Unit & 1 PD Unit Bracket	48
SEP48	48" table - Select Circuit 1 or Circuit 2	1 PD Unit & 1 PD Unit Brackets	48
SEP54	54" table - Select Circuit 1 or Circuit 2	1 PD Unit & 1 PD Unit Bracket	48
SEP60	60" table - Select Circuit 1 or Circuit 2	2 PD Units, 2 PD Unit Brackets & 7" Jumper	91
SEP72	72" table - Select Circuit 1 or Circuit 2	2 PD Units, 2 PD Unit Brackets & 14" Jumper	94
SPEH1	Hard-wire for Syntech shared leg only		85
SPEP1	72" Length Power Entry Straight Plug for Syntech freestanding only		168

EXTRA

Model #	Description	Price
SJ48	48" Jumper for Syntech only	93
SJ54	54" Jumper for Syntech only	120
CC1	Clips	25

8-TRAC – (4) 20 AMP CIRCUIT SYSTEM

Used for hard-wire power which needs to connect tables in longer, more permanent situations, where an isolated circuit is needed. Can be used on most training/classroom table application with an enclosed wire management gallery. Designed to be installed attached to gallery or under surface mounting (depends on table series) but should be inside wire management gallery when possible. Not appropriate for Syntech tables.

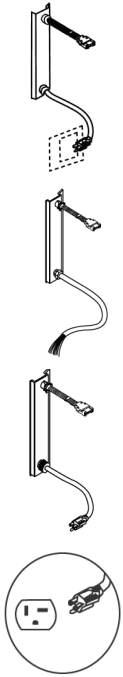

POWER ENTRY

Model #	Description	Price
PEQ1	Quick-Connect Power Entry for 29"H MATS freestanding Tables	320
PEQ2	Quick-Connect Power Entry for 27"H & 29"H MATS Shared Leg Tables - includes wall Rotating Power Entry	320
PEQ3	Quick-Connect Power Entry for 38"H MATS Shared Leg Tables - includes wall Rotating Power Entry. Wall/floor box requires installation by a licensed electrician.	320
PEH1	Hard-wire power entry (Universal) for 29"H MATS freestanding tables.	303
PEH2	Hard-wire Power Entry (Universal) for 27"H & 29"H MATS Shared leg tables	303
PEH3	Hard-wire Power Entry (Universal) for 38"H MATS Shared leg tables. 8 wire, 4 circuit, 80 amp available per power entry. Requires installation by a certified electrician. Cord length 6'0" standard.	303
PEP1	20-Amp Single Circuit Power Entry (Universal) for 29"H MATS freestanding tables - Circuit I only.	312
PEP2	20-Amp Single Circuit Power Entry (Universal) for 27"H & 29"H MATS shared leg - Circuit I only.	312
PEP3	20-Amp Single Circuit Power Entry (Universal) for 38"H MATS shared leg - Circuit I only.	312

ELECTRICAL POWER DISTRIBUTION

Single In-Line for MATS shared leg

Includes one duplex receptacle per junction block

Model #	Description	Price
PDES30	30" Table Power Distribution	108
PDES36	36" Table Power Distribution	157
PDES42	42" Table Power Distribution	192
PDES48	48" Table Power Distribution	201
PDESC48	48" Corner Table Power Distribution	247
PDES54	54" Table Power Distribution	208
PDES60	60" Table Power Distribution	214
PDES72	72" Table Power Distribution	229

Double Back-to-Back for MATS shared leg

Includes two duplex receptacles per junction block

Model #	Description	Price
PDEB30	30" Table Power Distribution	128
PDEB36	36" Table Power Distribution	200
PDEB42	42" Table Power Distribution	232
PDEB48	48" Table Power Distribution	241
PDEBC48	48" Corner Table Power Distribution	247
PDEB54	54" Table Power Distribution	250
PDEB60	60" Table Power Distribution	255
PDEB72	72" Table Power Distribution	271

Note: Circuit I standard when using PEP1/2/3. Specify Circuits: I, II, III, IV when using PEH1/2/3 or PEQ1/2/3

POWER DISTRIBUTION UNITS - INSTALLED IN WIRE MODESTY GALLERY

Model #	Description	Price
PD42	42" Table Includes: 1 single junction block, 1 placement bracket, 1 receptacle	76
PD48	48" Table - Includes: 2 single junction blocks, 1 placement bracket, 2 receptacles	109
PD60	60" Table - Includes: 2 single junction blocks, 1 placement bracket, 2 receptacles	160
PD72	72" Table - Includes: 2 single junction blocks, 1 placement bracket, 2 receptacles	175

Note: Circuit I standard when using PEP1. Specify Circuits; I, II, III, IV when using PEH1

EXTRA

Model #	Description	Price
RCPT1	Duplex Receptacle (must specify circuits I, II, III, IV)	25
J30	30" Jumper - MATS shared leg	132
J54	54" Jumper - MATS freestanding	155
J72	72" Jumper - MATS freestanding	175

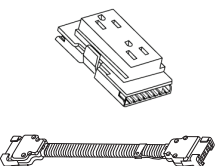
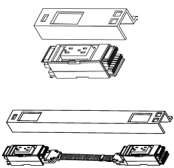

ACCESSORIES

COMMUNICATION KITS

Model #	Description	Price
DC1	Down-Leg Communication Channel	33
CMM1	Communications Kit - RJ45 8-Pin CAT 5	85
CMM2	Communications Kit - RJ11 6-Pin CAT 3	54
CMM3	Face Plate & Adapter Kit for Customer's Own Communication	11

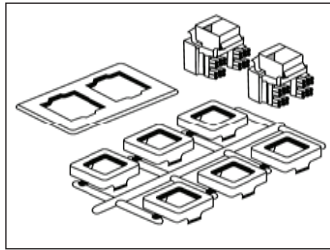

CMM1 w/face plate, adapter kit and two RJ45 8 pin couplers CAT 5 Amp #406372-2. Requires hardwiring by customer.

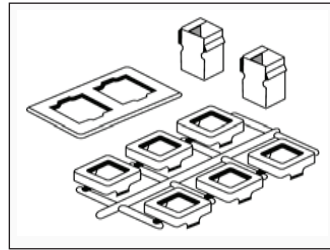

CMM2 w/face plate, adapter kit and two RJ11 6 pin couplers CAT 3 Amp #555050-1

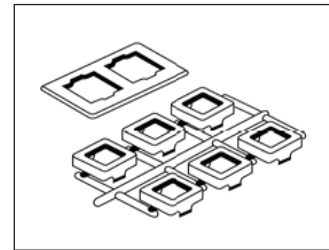

CMM3 w/face plate and adapter kit. Adapts to most standard industry couplers. See chart below

Notes:

- Face plates install in standard knockouts.

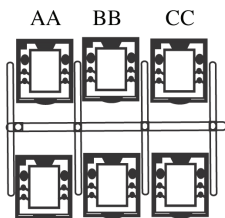







Adapter	Type of Coupler/Jack
AA	AT&T/Lucent Technologies Category 5
BB	Amp Category 5/Panduit Category 5
CC	Amp Category 3/Krone Category 5

Adapters accommodate couplers and jacks by the following manufacturers:

- Amp** 1-800-522-6752
- Leviton** 1-800-722-2082
- Lucent** 1-800-427-7127
- Krone** 1-800-775-5766
- Panduit** 1-800-777-3300

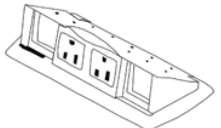
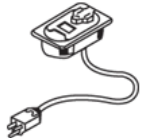
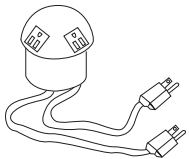
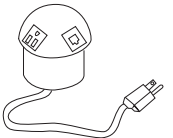
ACCESSORIES

Simple options that bring the electrical connection to the work surface top for easy access and plug in without needing to find plug/power source.

Model #	Description	Price
 GRM2	Grommet Includes: grommet and cover, installed. Color: Black. Size 2 3/8" diameter Grommet will be located 8 1/2" in from the right short edge and 2 1/2" from the back edge. You may also specify location on your order.	82
 GRM3	Grommet Single Includes: grommet and cover, installed. Color: Black. Size: 2 1/4" x 4" Grommet will be located 8 1/2" in from the right short edge and 2 1/2" from the back edge. You may also specify location on your order.	82
 MIPT2	Miniport (door stays open when in use) 2 Simplexes. 6 feet, 15 amp cord. 2 Voice/Data ports. Color: Black. Specify location.	226
 GRM8	Flush Mount Grommet Includes: grommet and 1 simplex installed. Size: 2" x 4". Color: Black. Grommet will be located 8 1/2" in from the right end and 2 1/2" from the back edge. Specify location.	92
 PS1	Power Sphere - Power Includes: 4 simplexes, 15 amp, two 6' cords, installed. Also available with data only ports. Size: 3 1/2" diameter. Color: Black. Grommet will be centered and installed 2 7/8" from back edge in center. Specify location.	244
 PS2	Power Sphere - Power & Communication Includes: 2 simplexes, 15 amp, two 6' cords, 2 spaces (customer's own communication), installed. Size: 3 1/2" diameter. Color: Black or Silver. Grommet will be centered and installed 2 7/8" from back edge in center. Specify location.	281
 PET	Temporary Power Strip 15 amp, 4 simplex receptacles. 10' cord. Color: Black	259
 EXP / MHO	Power/Data Center (single sided unit, five ports) Includes: 2 simplexes, 15 amp, 3 data ports, 72" power cord Standard with single side, double sided also available Available from two to eight ports per side Finish: clear anodized aluminum. Specify location.	387
 AAP	Adapter Bracket (Upcharge to EXP price) Available on EXP unit only. Adapter plate provides configuration options for audio and visual components	46 upcharge to EXP price

Note: Cut Out only, add \$43 to price of table.
 Must supply template and placement information with the order.

ACCESSORIES



Model #	Description	Price
EXP2	Power/Data Center (double sided unit, five ports) Includes: 2 simplexes, 15 amp, 1 active USB hub, 1 modular data opening, 72" power cord. Standard with single side, double sided also available. Available from two to eight ports per side. Contact customer service or your sales representative for additional information. Finish: clear anodized aluminum. Specify location.	760
PASSIVE USB-A JACK	PASSIVE USB-B JACK Includes: 48" cord	43 upcharge to EXP2 price
PASSIVE USB-B JACK	PASSIVE USB-A JACK Includes: 48" cord	43 upcharge to EXP2 price
GLB-65	GLENBEIGH CONTEMPORARY Two position. Available in: satin nickel plated or powdercoat, silver, black or parchment (white). Specify location. Specify Contemporary on order	345 Plated 250 Powdercoat
GLB-65	GLENBEIGH TRADITIONAL Two position. Available in: satin nickel plated or powdercoat, silver, black or parchment (white). Specify location. specify Traditional on order	345 Plated 250 Powdercoat
POWER CONSOLE	POWER CONSOLE Console may be added between two wallbenches, or at the end of a unit, adds 8" Standard is laminated, may be upholstered (call for quote) Add your electrical option price to console price for the complete unit price Price includes cut out per electrical option selected Shown here with GLB-65 power option	612
ECLIPSE	ECLIPSE Includes: 3 standard outlets standard, or 2 outlets 1 USB 2-Port Charger upcharge Available in: soft touch black, white, orange, or green plastic, standard Cord: 72" standard, 120" \$10 upcharge	249 3 Power 319 2 Power, 1 USB
HEMISPHERE	HEMISPHERE Includes: 3 standard outlets standard, or 2 outlets 1 USB 2-Port Charger upcharge Available in: soft touch black, white, orange, or green plastic, standard Cord: 72" standard, 120" \$10 upcharge	164 3 Power 225 2 Power, 1 USB
AXIL Z	AXIL Z Includes: 2 power, 1 USB Charger and 1 Open Data Available in: black and white painted finishes	563

Note: Cut Out only, add \$43 to price of table.
Must supply template and placement information with the order.

ACCESSORIES

Simple options that bring the electrical connection to the work surface top for easy access and plug in without needing to find plug/power source.

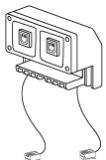
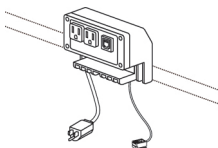
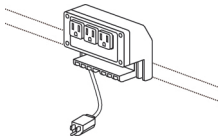
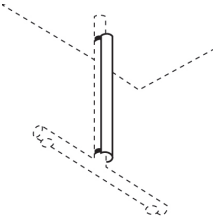
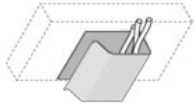

Model #	Description		Price
WM2	J channel under table wire manager Black Plastic	WM-2-F 48"	73
		WM-2-G 60"	81
		WM-2-H 72"	86
MESH WIRE BAG	Mesh Wire Bag Under table horizontal wire management, Kit includes: sheerweave mesh, 2 velcro loops, 2 velcro hooks	24"	111
		9"	54
HAMPTON LEG	Hampton Leg (Vertical Wire Manager) Priced per set, includes: three standard 2" columns, one 2' wire mgr column, metal carpet glides. Also available with 3" columns, call for quote Also available as column only to add to table base, priced each, add to table base price	6502 Grd1&2, Std ht	446
		6502 Grd5, Std ht	629
		SU6502 Grd1&2, Stand-Up ht	701
		SU6502 Grd5, Stand-Up ht	883
WM6B	Clip on Leg Wireway Used for Folio tables only. Finish black.		71
WL27	Aluminum Legway Wire Manager Powdercoat finish to match leg, not available in polished chrome Use on Storm tables only.		81
PDC1	ADAPT clamp on unit Includes: 3 standard outlets, 1 circuit, 15 amp. 6' power cord. Black plastic		229
PDC2	ADAPT clamp on unit Includes: 2 standard outlets, 1 circuit, 15 amp 1 data connector, RJ45, CAT5 6' power cord 6' data cord Black plastic		229
PDC4	ADAPT clamp on unit Includes: 2 data communications outlets (RJ45, CAT5) two 6' data cords		229

ELECTRICAL WORKSHEET

We have a variety of power solutions appropriate for any of your power requirements. Please take a moment to evaluate your project and complete the following check list. It will help determine which power solution best fits your needs. After you have answered these questions, contact your sales representative, or customer service representative, who will assist you with the specific details for adding the power option to your table order.

My client is powering more than one table (Y/N)

- _____ Our plan calls for less than 16 users per row
- _____ I need data brought into the tables
- _____ I need power at the top surface
- _____ I need power accessible below the table for CPU's to plug into
- _____ The room is permanent and will not be reconfigured
- _____ The room will have bolt down tables
- _____ Power is currently available in the wall
- _____ Power is currently available in the floor
- _____ New construction, power can be located anywhere
- _____ What is the desired table length
- _____ How many users per table

SOLUTIONS

I. Simple Power

Simple power is defined as a 15 amp plug that is inserted into a standard outlet. Each electrical component in the table would plug directly into the floor or wall. This power is commonly used with conference tables or very small training rooms.

II. Table Top Daisy Chain Power

This power allows you run rows of tables in a training room. Up to 16 users (2 per unit) can generally be provided with power from one access point. If there are more than 16 users, additional access points must be designated. The type of power can be applied using one of the following options.

a. Interlink

- 12 amp system rating with 15 amp power cord
- Up to 8 duplexes devices such as Miniports
- Meets UL 962

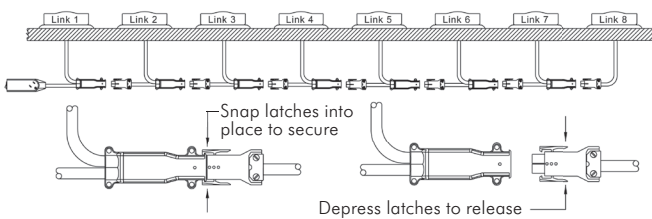

b. Nonsequential

- 12 amp system rating with 15 amp power cord
- Up to 8 duplexes devices such as Miniports
- Meets UL 962

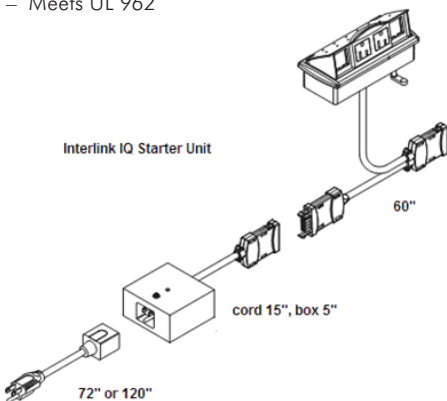

What will be plugged into each table:

- Number of Computers
- Number of Monitors
- Number of Printers or other equipment

Does the building have 15 amp power available (Y/N)

Does the building have 20 amp power available (Y/N)

Note: Falcon's standard power options do not meet Chicago or New York codes, contact your sales representative for assistance.

c. Interconnect

- 8-wire, 4-circuit system or 4-wire 2-circuit system depending on power need.
- 20 amp per circuit rating
- UL 183.
- Must be hard wired to the building or utilize quick connect.
- Building must be wired for 20 amp rating.



III. Fully Integrated Power within the Wire Manager and Table Top

This solution allows for computer rooms to power a CPU, monitor, printer, etc. from underneath the table surface as well as power other ancillary equipment from the top surface. It allows for long runs of power with the ability to segregate for clean circuits.

- 20 amp single circuit solution that utilizes a 20 amp plug.
- 2 circuit system that is rated at 20 amps per circuit (requires hardwiring to the building)
- 4 circuit system that is rated at 20 amps per circuit (requires hardwiring to the building)
- Building must be wired for 20 amp rating
- UL1286 Rated



Information is for planning purpose only. Contact a licensed electrician to ensure required building codes are met.

IV. Small Order Charge

Orders with a combined Net price under \$1,000 will be subject to a Special Handling Charge of \$125 Net. One charge per order.

GLOSSARY OF ELECTRICAL TERMS

Amps, Amperage

Unit of electrical current. Considered to be the volume of electricity flowing through a wire (compare to voltage, wattage).

Chicago and New York Codes

Falcon's standard power options do not meet these requirements, contact your sales representative for additional information.

Circuit

A complete electrical path that leads from a power source, through an electrical device, and back to the source.

Conduit

Metal housing that is required by most codes for the protection of power-carrying wires. May either be a rigid casing or flexible tubing.

Dedicated Circuit

One circuit that is set aside, by nature of the system, for a specific use. For example, the four-wire 20 amp power cord has a dedicated ground wire which cannot be accessed by other circuits because terminals are polarized.

Downrated Circuit

A circuit that is under load continuously for three or more hours. To protect wires and terminals from overheating under this load, the circuit rating is lowered from the maximum 20 amps to 16 amps.

Hard-wire

An electrical connection made by stripping insulation from individual wires and physically joining them for a permanent installation. The hard-wire entry option must be performed by a licensed electrician who will connect the proper wires to support multiple option features.

Isolated Ground

Power in a specific circuit that has been protected from interference created in other circuits.

NEC, National Electrical Code

This comprehensive set of electrical codes developed by the National Fire Protection Association is available by writing:

National Fire Protection Association
Battermarch Park
Quincy, MA 02269

UL, Underwriter's Laboratories

Created by insurance underwriters as a nationally recognized testing laboratory for evaluating commonly insured products. Information may be obtained by writing:

Underwriter's Laboratories
333 Pfingsten Road
North Brooke, IL 60062

Volt, Voltage

Unit of electrical pressure in a circuit. Compare this to amperage which is the volume of current.

Watt, Wattage

A measure of electrical power. Equal to electrical pressure (voltage) multiplied by volume (amperage) in a circuit (ie: 120 volts multiplied by 1.5 amps equals 180 watts).

The Falcon Advantage 3
 How to Order 4
 Base and Table Finishes 5
 Table Top Options 6

FOLIO TABLES 7

Folding Tables 8
 24FT Rectangle 8
 24FT Round 8
 24FT Racetrack 9
 24FL Lightweight Rectangle 9
 24FA Folding Modesty Panel 9

Stationary Tables 10
 24TT Rectangle 10
 24TT Round 10
 24TT Square 10
 24TM Fixed Modesty Panel 11

Stationary Shapes 12
 24TS Rectangle 12
 24TS Trapezoid 12
 24TS Quarter Round 13
 24TS Half Round 13
 24TS Crescent 13

Folio Table Specifications 14
 Folio Table Options 15
 Folio Table Finishes 16

MATS TABLES 17

Portable Lightweight Folding 19
 Rectangle 19
 Trapezoid 20
 Half Round 20
 Quarter Circle Crescent 20
 Portable Shapes and Configurations 21

Freestanding Stationary 22
 Rectangle 22
 Trapezoid 23
 Half Round 23
 Quarter Circle Crescent 23

Freestanding Pedestal & Pin Leg 24
 Pedestal Base Square 24
 Pedestal Base Round 24
 Pedestal Base Rectangle 24

Pin Leg Base Square 24
 Pin Leg Base Round 24
 Freestanding Options 25
 Portable and Freestanding Options 26
 Lecture Features and Benefits 27

Shared Leg Stationary Tables 28
 41S Freestanding/Starter 28
 42A Add On 28
 41S Corner Chamfer 29
 42A Corner Chamfer 29

In-Line Screen Grouping 30
 41LD Freestanding Starter 30
 42LD Add On 30

Back-to-Back Screen Grouping 31
 41BD Freestanding/Starter 31
 42BD Add On 31

Corner Screen Grouping 32
 41LC Freestanding Starter 32
 42LC Add On 32

Back-to-Back Corner Screen Grouping 32
 41S Freestanding/Starter 32
 42A Add On 32

Starter and Add on Modesty Panels 33
 MODP2 33
 MODP2C 33
 MODPS 33
 MODPSC 33
 MODPA 33
 MODPAC 33

ADA Compliance 33
 WCK49 33

MATS Project Planner and Checklist 35
 MATS Ordering Information 36
 MATS Power Solutions 37
 Edges and Colors 38

SPECTRA TABLES 40

Stationary Tables 41
 SP3F Square 41
 SP3F Rectangle 41
 SP3F Trapezoid 42
 SP3F Truncated Triangle 42
 SP3F Quarter Round 42
 SP3F Half Round 43
 SP3F Round 43

Folding Tables 44
 SP5F Square 44
 SP5F Rectangle 44
 SP5F Trapezoid 45
 SP5F Half Round 45
 SP5F Round 45

Training Stationary Tables 46
 SP3FA Square 46
 SP3FA Rectangle 46
 SP3FA Trapezoid 47
 SP3FA Truncated Triangle 47
 SP3FA Quarter Round 48
 SP3FA Half Round 48

Training Folding Tables 49
 SP5FA Square 49
 SP5FA Rectangle 49
 SP5FA Trapezoid 50
 SP5FA Half Round 50
 Spectra Specifications 51
 Spectra Finishes 53

STORM TABLES 54

Stationary Tables 56
 ST3TC Clamp On Modesty Panel 56
 ST3CC Clamp on Modesty Panel 56
 ST3TA Folding Modesty Panel 56
 ST3CA Folding Modesty Panel 56
 ST3T Rectangular 57
 ST3C Rectangular 57
 ST3X Square Pedestal Base 58
 ST3X Rectangular Pedestal Base 58
 ST3X Round 58
 ST3T Racetrack 59
 ST3T Boatshape 59
 ST3T Trapezoid 60
 ST3T Quarter Round 60

ST3T Half Round	60	SYNTECH TABLES	79	65CV-CT Curve Rectangle	95
ST3T Crescent	60	250CS Starter	80	65CV-CT Curve Conference	96
ST6TN/ST6CN Rectangle	61	250CA Add On	80	65CV-WA Curve Wave	96
ST6TNM/ST6CNM Modesty Panel	61	250CSM Starter w/ Modesty	81	Conference & Meeting Tables	97
Flip Top Tables	61	250CAM Add on w/ Modesty	81	J91CT Round	97
ST6X Square	62	25NS/25NC Flip/Nesting Tables	82	J91CT Square	97
ST6X Rectangle	62	25NSM/25NCM Flip/Nesting Tables	82	J91CT Rectangular	97
ST6X Round	62	Meeting & Conference Tables	82	J91CT Racetrack	98
ST6T Rectangle	63	25SS Rectangle	82	J91CT Boatshape	98
ST6TC Clamp on Modesty Panel	63	25SS Racetrack	83	J11CT Round	99
ST6T Trapezoid	64	25MC Media Conference	83	J11CT Square	99
ST6T Half Round	64	Multi-Surface Meeting Tables	83	J11CT Racetrack	100
ST6T Crescent	64	25NW Network Pod	83	J11CT Boatshape	100
ST6TB Rectangle	65	25CCE Curved End	84	24CT Rectangular	101
ST6TB Trapezoid	65	25CSE Straight End	84	24CT Round	101
ST6TB Half Round	65	25CCR Crescent Connector	84	24CT Square	101
ST5T Square	66	25CHR Half Round	84	24CT Racetrack	102
ST5T Rectangle	66	25C45 Connector- 45°	84	24CT Boatshape	102
Light Weight Folding	67	25C90 Connector- 90°	84	31 CT Round	103
ST5T Light Weight Rectangle	67	25CW Wedge Connector	84	31 CT Square	103
ST5TA Light Weight Folding Modesty Panel	68	Syntech Features, Options, and Finishes	85	31 CT Rectangular	103
ST5CR Light Weight Removable Modesty Panel	68	Syntech Edge Profiles	86	31 CT Racetrack	104
Folding Tables	69	SYMEYTIS TABLES	87	31 CT Boatshape	104
ST5CR Removable Modesty Panel	69	Stationary Tables	88	51 CT Round	105
ST5TA Folding Modesty Panel	69	36S Starter	88	51 CT Square	105
ST5T Round	69	36 A Add on	88	51 CT Rectangular	105
ST5T Racetrack	70	Modesty Tables	89	51 CT Racetrack	106
ST5T Trapezoid	70	36NSM and NCM	89	51 CT Boatshape	106
ST5T Half Round	70	Krystalcast Modesty Panel	89	POWER SOLUTIONS	111
ST5T Crescent	70	36 NS and NC	89	MIPTI9Q Starter Unit	112
Bridges	71	36 TD teachers desk	90	MIPT9IQ Add On Unit	112
STB Bridges	71	Active Learning Tables	90	MIPT6	113
STSB Square Bridges	71	36POD	90	PS6	113
Adjustable Height	72	400 Series	91	IPT6	114
ST7X Round	72	CONFERENCE TABLES	92	IPT6S	114
ST7X Square	72	Single Surface Meeting Tables	93	IPT6DA	114
ST7T Rectangle	72	25SS Syntech Rectangle	94	IPT6SA	114
ST7TS Split Top	72	25SS Syntech Racetrack	94	PD4	115
Storm Specifications	74	25MC Syntech Media Conference	94	PEH4	115
Storm Options	76	65CV-CT Curve Round	95	Syntech Extra	115
Storm Finishes	78	65CV-CT Curve Square	95	Power Entry	116
				PEQ1	116
				PEQ2	116
				PEQ3	116
				PEH1	116

PEH2	116	PS1	118
PEH3	116	PS2	118
PEP1	116	PET	118
PEP2	116	EXP	118
PEP3	116	MHO	118
Electrical Power Distribution	116	AAP	118
PDES30	116	EXP2	119
PDES36	116	Passive USB-A Jack	119
PDES42	116	Passive USB-B Jack	119
PDES48	116	GLB-65 Contemporary	119
PDESC48	116	GLB-65 Traditional	119
PDES54	116	Power Console	119
PDES60	116	Eclipse	119
PDES72	116	Hempisphere	119
PDEB30	116	Axil Z	119
PDEB36	116	PDC1	120
PDEB42	116	PDC2	120
PDEB48	116	PDC4	120
PDEBC48	116	WM2	120
PDEB54	116	WM4A	120
PDEB60	116	Mesh Wire Bag	120
PDEB72	116	Hampton Leg	120
Power Distribution Units 116		WM6B	120
PD42	116	WL27	120
PD48	116	Electrical Worksheet	121
PD60	116	Glossary of Electrical Terms	123
PD72	116	Index	124
Extra	116		
RCPT1	116		
J30	116		
J54	116		
J72	116		
Communication Kits	117		
DC1	117		
CMM1	117		
CMM2	117		
CMM3	117		
Accessories	118		
GRM2	118		
GRM3	118		
MIPT2	118		
GRM8	118		